



million
in one

sitrans

LR400

SIEMENS

Safety Guidelines: Warning notices must be observed to ensure personal safety as well as that of others, and to protect the product and the connected equipment. These warning notices are accompanied by a clarification of the level of caution to be observed.

Qualified Personnel: This device/system may only be set up and operated in conjunction with this manual. Qualified personnel are only authorized to install and operate this equipment in accordance with established safety practices and standards.

Unit Repair and Excluded Liability:

- The user is responsible for all changes and repairs made to the device by the user or the user's agent.
- All new components are to be provided by Siemens Milltronics Process Instruments Inc.
- Restrict repair to faulty components only.
- Do not reuse faulty components.

Warning: This product can only function properly and safely if it is correctly transported, stored, installed, set up, operated, and maintained.

This product is intended for use in industrial areas. Operation of this equipment in a residential area may cause interference to several frequency based communications.

Note: Always use product in accordance with specifications.

Copyright Siemens Milltronics Process Instruments Inc. 2008. All Rights Reserved	Disclaimer of Liability
This document is available in bound version and in electronic version. We encourage users to purchase authorized bound manuals, or to view electronic versions as designed and authored by Siemens Milltronics Process Instruments Inc. Siemens Milltronics Process Instruments Inc. will not be responsible for the contents of partial or whole reproductions of either bound or electronic versions.	While we have verified the contents of this manual for agreement with the instrumentation described, variations remain possible. Thus we cannot guarantee full agreement. The contents of this manual are regularly reviewed and corrections are included in subsequent editions. We welcome all suggestions for improvement. Technical data subject to change.

MILLTRONICS® is a registered trademark of Siemens Milltronics Process Instruments Inc.

Contact SMPI Technical Publications at the following address:

Technical Publications
Siemens Milltronics Process Instruments Inc.
1954 Technology Drive, P.O. Box 4225
Peterborough, Ontario, Canada, K9J 7B1
Email: techpubs.smpi@siemens.com

European Authorized Representative

Siemens AG
Industry Sector
76181 Karlsruhe
Deutschland

- For a selection of Siemens Milltronics level measurement manuals, go to: **www.siemens.com/processautomation**. Under Process Instrumentation, select *Level Measurement* and then go to the manual archive listed under the product family.
- For a selection of Siemens Milltronics weighing manuals, go to: **www.siemens.com/processautomation**. Under Weighing Technology, select *Continuous Weighing Systems* and then go to the manual archive listed under the product family.

Table of Contents

General Information	1
Safety Notes	1
The Manual	1
Abbreviations and Identifications	2
SITRANS LR400	3
Structure	3
System Implementation	4
Programming	4
Specifications	5
SITRANS LR400	5
Dimensions	9
Air Purging System (Optional)	13
Installation	15
Mounting Location	15
Beam Width	16
Correct Installation in Mounting Nozzle	16
Electrical Connection	17
Start Up	19
Self-test	19
Multi-display	19
Local Programming	19
Auto-Setup	19
Operation	20
General Information	20
Operating SITRANS LR400	20
Selecting a Parameter	21
Structure of Parameters	21
Changing a Parameter Value	22
Disabling and Enabling Programming	23
Parameter Operating Examples	24
Parameters (HART)	26
Vessel Functional Dimensions	27
Required Parameters	27
Additional Parameters	29
Parameters (PROFIBUS PA)	68
Troubleshooting	81
Classification of Faults	81
Self-test	81

Symptoms, Causes and Their Remedy	81
Fault Messages	82
Unit Repair and Excluded Liability	84
Antenna Maintenance	86
Cleaning the Antenna	86
Hazardous Installation	87
Appendix I	88
Ambient/Operating Temperature Specification	88
Appendix II	89
Process Pressure/Temperature De-rating	89
Appendix III	91
Measuring Principle	91
Appendix IV	93
HART Communications for SITRANS LR400	93
HART Device Description (DD)	93
SIMATIC Process Device Manager (PDM)	93
HART Communicator 275/375:	94
Appendix V	97
PROFIBUS PA Communications for SITRANS LR400	97
Device Description	97
The GSD file	97
Bus address (Device Address)	97
Bus Termination	98
Power Demands	98
Cyclic versus Acyclic Data	98
Cyclic Data	98
Status Word	100
Extended Diagnostics	101
Acyclic Data	101
Configuration Example:	101
Appendix VI: Firmware Revision History	102
Glossary	104
Index	107

General Information

Safety Notes

Special attention must be paid to warnings and notices highlighted from the rest of the text by grey boxes.



WARNING: relates to a caution symbol on the product, and means that failure to observe the necessary precautions can result in death, serious injury, and/or considerable material damage.



WARNING: means that failure to observe the necessary precautions can result in death, serious injury, and/or considerable material damage.

CAUTION: means that failure to observe the necessary precautions can result in considerable material damage.

Note: means important information about the product or that part of the operating manual.

- These instructions do not claim to cover all details or variations in equipment, or to provide for every possible contingency that may arise during installation, operation, or maintenance.
- For further information or to resolve issues not covered in the manual, consult your Siemens Milltronics representative.

The Manual

IMPORTANT: All specifications are subject to change without notice. Please ensure that any safety-related information is confirmed with a qualified Siemens Milltronics representative.



WARNINGS:

- Changes or modifications not expressly approved by Siemens Milltronics could void the user's authority to operate the equipment.
- This equipment is intended to be used only in fully enclosed metal and concrete containers.

Note: This equipment has been tested and found to comply with the limits for a Class A digital device, pursuant to Part 15 of the FCC Rules. These limits are designed to provide reasonable protection against harmful interference when the equipment is operated in a commercial environment. This equipment generates, uses, and can radiate radio frequency energy and, if not installed and used in accordance with the instruction manual, may cause harmful interference to radio communications. Operation of this equipment in a residential area is likely to cause harmful interference in which case the user will be required to correct the interference at his own expense.

This manual will help you set up your SITRANS LR400 for optimal performance. This manual applies to the HART and PROFIBUS SITRANS LR400. For HART parameters, please see page 26. For PROFIBUS PA parameters, see page 68. We always welcome suggestions and comments about manual content, design, and accessibility.

Please direct your comments to techpubs.smpi@siemens.com. For the complete library of Siemens Milltronics manuals, go to www.siemens.com/processautomation.



WARNINGS:

- Installation shall only be performed by qualified personnel and in accordance with local governing regulations.
- The SITRANS LR400 is to be used only in the manner outlined in this manual, otherwise protection provided by equipment may be impaired.

Note: This product is intended for use in industrial areas. Operation of this equipment in a residential area may cause interference to several frequency based communications.

Qualified personnel

Qualified personnel are familiar with the installation, commissioning, and operation of this equipment. In addition the person must be:

- trained and authorized to operate and service equipment/systems in accordance with established safety procedures relating to electrical circuits, high pressures and aggressive media.
- trained in the proper care and use of protective equipment in accordance with established safety practices.
- trained in rendering first aid.

Abbreviations and Identifications

Short form	Long form	Description
CE / FM / CSA	Conformité Européene / Factory Mutual / Canadian Standards Association	safety approval
ESD	Electrostatic Discharge	
HART®	Highway Addressable Remote Transducer	
IS	Intrinsically Safe	safety approval
LRV	Lower Range Value	value for process empty level (symbol 4 mA) ¹
PED	Pressure Equipment Directive	safety approval
URV	Upper Range Value	value for process full level (symbol 20 mA) ¹

¹ 100% is most commonly set to 20 mA and 0% to 4 mA.

HART is a registered trademark of the HART Communication Foundation.

SITRANS LR400

SITRANS LR400 is a long-range FMCW radar level transmitter. It is suitable for use in liquids and solids, for low dielectric liquids, and high pressure applications or applications with extreme dust. This version also incorporates a purging option for sticky solids applications. The narrow antenna beam results in a sharp emission cone, which makes SITRANS LR400 quite insensitive to vessel interferences.

Note: This manual applies to the 7ML5421 version only. Please see Instruction Manual 7ML19985JC02 for information about the SITRANS LR400, 7ML5420 version.

Structure

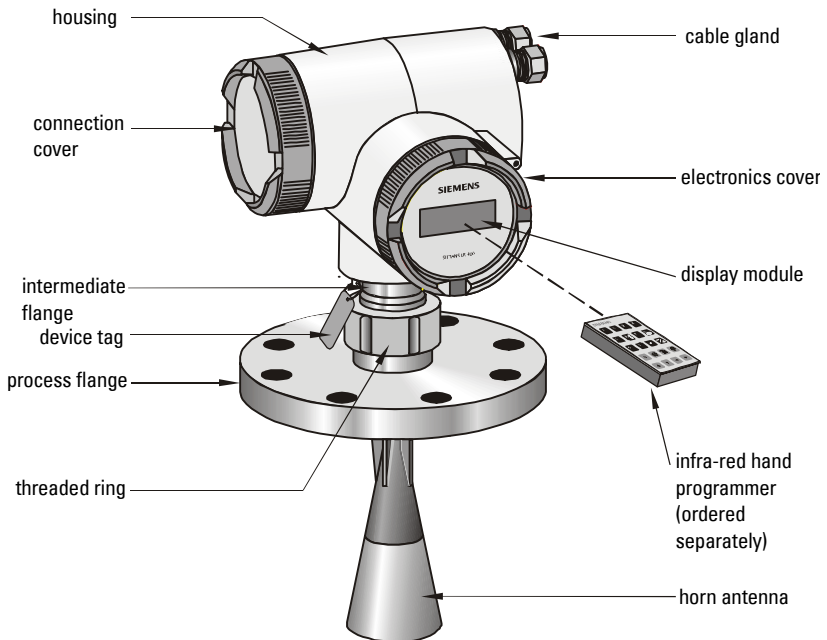

The terminals for the power cable and the signal cable are behind the connection cover on the left side of the housing. The signal cable must be fed in from the right through the cable glands.

The end of the antenna must reach inside the vessel through the vessel nozzle (see page 16).

If the device is rotated, return the orientation of the housing to its previous position with reference to the enclosure, to ensure similar performance.

System Implementation

SITRANS LR400 supports HART communication protocol, and SIMATIC PDM software.

Typical PLC/mA configuration with HART

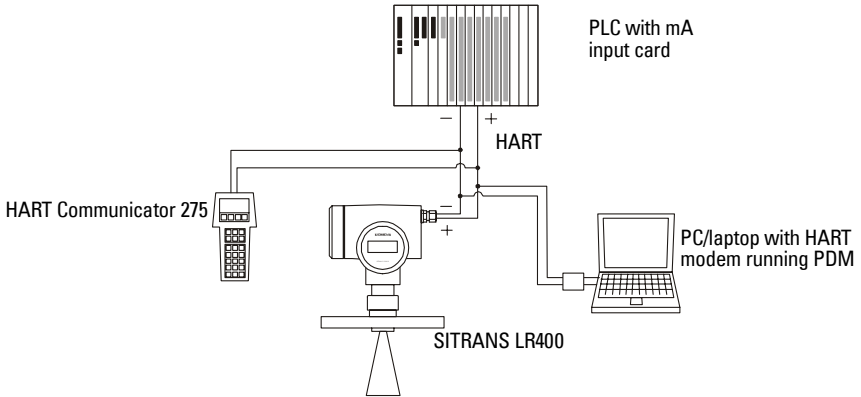

Note: A 250 ohm loop resistor may be required, depending on PLC input resistance.

Typical PLC/mA configuration with PROFIBUS PA

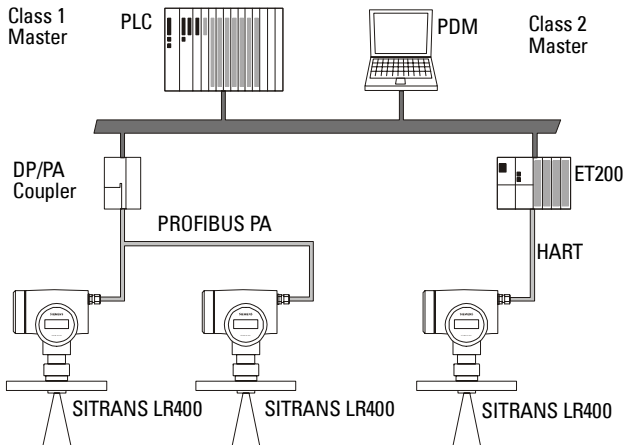

Programming

SITRANS LR400 carries out its level measurement function according to the set of built-in parameter tables. You can make parameter changes via the hand programmer, a PC running SIMATIC PDM or a HART handheld communicator.

Specifications

Note: Siemens Milltronics makes every attempt to ensure the accuracy of these specifications, but reserves the right to change them at any time.

SITRANS LR400

Power

Power Supply

- 100 to 230 V AC, $\pm 15\%$, 50/60 Hz, 6 W
- 24 V DC, +25/-20%, 6 W
- Fuse (AC)

SI1	Fast acting ceramic, 4 x 20 mm, 1 A, 250 V AC
SI2	Slow-Blow, 4 x 20 mm, 0.63 A, 250 V AC
- Fuse (DC)

SI1	Fast acting ceramic, 4 x 20 mm, 2 A, 250 V AC
SI2	Slow-Blow, 4 x 20 mm, 0.63 A, 250 V AC

Performance

- Frequency 25 GHz nominal
- Measuring range 0.35 to 50 m (1.15 to 164 ft)

Measured value error (under reference conditions)

- Measuring error $\leq \pm 5$ mm (0.2") at 1 to 10 m (3.3 to 32.8 ft.) distance
 $\leq \pm 15$ mm (0.6") at 10 to 50 m (32.8 to 164 ft) distance
- Dead band¹ 0 to 350 mm from bottom edge of flange
- Additional contribution of analog output $\leq 0.1\%$
- Long-term stability $\leq \pm 1$ mm/year
- Repetitive accuracy $\leq \pm 1$ mm at 0 to 50 m, damping ≥ 1 s

Interface

- Analog output (Not applicable to PROFIBUS PA option)

Signal range	4 to 20 mA
Fail signal	3.6 mA; 22.5 mA or last value
Load	Max. 600 Ω ; (330 Ω for [ia] versions, Area classification options G, L, P, S) ² , for HART ³ communication min. 230 Ω

1. For solids applications, setting a dead band of 1 m is recommended because of lower reflectivity and increased angles of repose.
2. See Selection and Ordering Data sheet
3. HART[®] is a registered trademark of HART Communication Foundation.

Relay	Configurable as a device status or limit value (level, volume, mass) Either NCC or NOC function max. 50 V DC, max. 200 mA, rating max. 5 W. Self-resetting fuse, $R_i = 9 \Omega$
• Electrical isolation	Outputs electrically isolated from the power supply and from each other
• Display	LCD, two lines of 16 characters each, configurable for the following displays: level, volume, mass, amplitude, digital output, temperature, validity, signal-to-noise ratio

Programmer (infrared keypad)

Siemens Milltronics Infrared IS (Intrinsically Safe) hand programmer for hazardous and all other locations (battery is non-replaceable)

- approval: ATEX II 1 G, EEx ia IIC T4, certificate SIRA 01ATEX2147
CSA and FM Class I, Div. 1, Gr. A, B, C, D T6 @ max. ambient temperature of 40 °C (104 °F)
- ambient temperature: –20 to 40 °C (–5 to 104 °F)
- interface: proprietary infrared pulse signal
- power: 3 V lithium battery
- weight: 150 g (0.3 lb)
- color: black

Mechanical

Flange

- Process Connection Flange DIN 2527, ANSI B16.5, or JIS B2238 equivalent bolt pattern (See page 11 for flange dimensions.)
- Materials of the wetted parts – in contact with the process Stainless steel 316/316L flange and 304 horn, PTFE emitter (or glass/PTFE, Zone 0 and Zone 20 devices)
- Pressure (vessel) Varies with connection type. Refer to Appendix IV for specifications.
- Horn types Short horn, 74 mm (2.9") diameter
Long horn, 93 mm (3.7") diameter

Weight

- Weight of instrument and flange

Process Connection	Weight
DN80 PN16, flat faced	11.9 kg (26.1 lbs)
DN80 PN40, flat faced	12.9 kg (28.4 lbs)
DN100 PN16, flat faced	13.2 kg (28.9 lbs)
DN100 PN40, flat faced	15.5 kg (34.1 lbs)
DN150 PN16, flat faced	19.2 kg (42.1 lbs)
DN150 PN40, flat faced	24.1 kg (43.1 lbs)
3", 150 lb class, raised faced	12.2 kg (26.8 lbs)
3", 300 lb class, raised faced	14.3 kg (31.5 lbs)
4", 150 lb class, raised faced	14.8 kg (32.5 lbs)
4", 300 lb class, raised faced	20.2 kg (44.4 lbs)
6", 150 lb class, raised faced	20.1 kg (44.2 lbs)
6", 300 lb class, raised faced	31.8 kg (69.9 lbs)
JIS DN80 10K, flat faced	11.9 kg (26.1 lbs)
JIS DN100 10K, flat faced	13.2 kg (28.9 lbs)
JIS DN150 10K, flat faced	19.2 kg (42.1 lbs)
Universal, 3" / 80 mm, flat faced, 0.5 bar maximum (purge option)	10.9 kg (24 lbs)
Universal, 4" / 100 mm, flat faced, 0.5 bar maximum (purge option)	12.7 kg (28 lbs)
Universal, 6" / 150 mm, flat faced, 0.5 bar maximum (purge option)	15.0 kg (33 lbs)

! **WARNING:** This product is designated as a Pressure Accessory per Directive 97/23/EC and is not intended for use as a safety device.

Enclosure

- construction Die-cast aluminum, painted (polyester powder-coated)
2 x M20
or 2 x ½" NPT (option)
- conduit
- ingress protection Type 4X/NEMA 4X, Type 6/NEMA 6, IP67¹

Environmental²

- location indoor/outdoor
- altitude 2000 m (6562 ft) max
- ambient temperature³ -40 to 65 °C (-40 to 149 °F)
- relative humidity suitable for outdoor (Type / NEMA 4X, 6/ IP67)
- installation category II
- pollution degree 4
- Perm. ambient temperature -40 to 65 °C (-40 to 149 °F) (non-hazardous version)
LCD: -10 to 55 °C (14 to 131 °F)
Observe the temperature classes in hazardous areas!

! **WARNING:** Materials of construction are chosen based on their chemical compatibility (or inertness) for general purposes. For exposure to specific environments, check with chemical compatibility charts before installing.

1. Use only approved, suitable sized hubs for **watertight** applications.
2. See Process/Ambient de-rating curves in Appendix III.
3. -20 °C (-4 °F) temperature rating available on SITRANS LR400 with ATEX rating.

Process

- Process Temperature -40 to 200 °C (-40 to 392 °F)
Optional (7ML5421 version) -40 to 250 °C (-40 to 482 °F)
- Pressure (vessel) Varies with connection type. Refer to Appendix IV for specifications.

Communication

- Communication: HART
 - Load 230 to 600 Ω, 230 to 500 Ω when connecting a coupling module
 - Line two-wire shielded: ≤ 3000 m
multi-wire shielded: ≤ 1500 m
 - Protocol HART, Version 5.1
- Communication: PROFIBUS PA
 - Protocol Layer 1 and 2 PROFIBUS PA,
technology: IEC 61158-2, slave-functionality
 - Device Class A
 - Device Profile 3.0
- Software for PC/Laptop Windows 95/98/2000/XP or NT 4.0
SIMATIC® PDM

Approvals (verify against device nameplate)

- Explosion Protection Certificate No. PTB 00 ATEX 1024
*Refer to device nameplate II 1/2G EEx d IIC T6II 2G EEx d IIC T6
II 1/2G EEx dem IIC T6II 2G EEx dem IIC T6
II 1/2G EEx dem [ib] IIC T6II 2G EEx dem [ib] IIC T6
II 1/2G EEx dem [ia] IIC T6II 2G EEx dem [ia] IIC T6
FM/CSA Class I, Div. 1, Groups B, C, D; Class II/III, Div. 1, Groups E, F, G
- General CSAus/c, FM, CE
- Radio FCC, Industry Canada, European Radio(R&TTE)
- Shipping - Lloyd's Register of Shipping, Categories ENV1, ENV2, ENV3, and ENV5
- ABS



WARNING: This product is designated as a Pressure Accessory per directive 97/23/EC and is not intended for use as a safety device.

Dimensions

SITRANS LR400 (7ML5421 version) (without Temperature Extension)

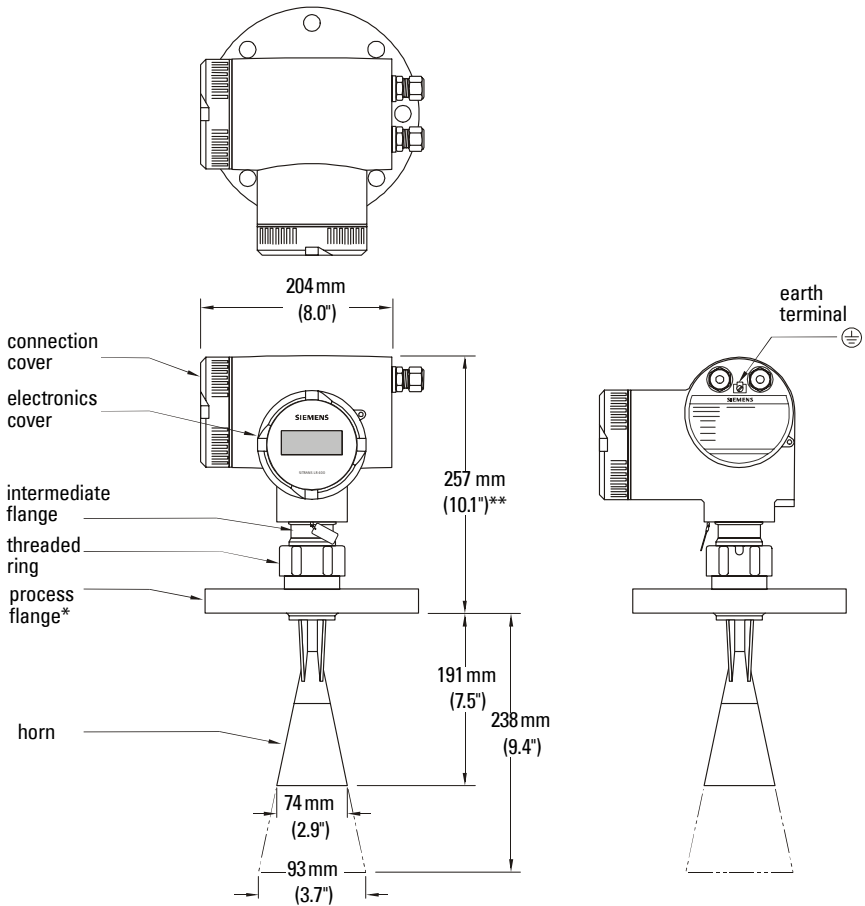

Note: Process temperature and pressure capabilities are dependent upon information on the process device tag. See Appendix IV (Process Pressure/ Temperature de-Rating). Reference drawing listed on the tag is available upon request.

! **WARNING:** The user is responsible for the selection of bolting and gasket materials which will fall within the limits of the flange and its intended use and which are suitable for the service conditions.

*Flange according to DIN 2527 / ANSI B 16.5 / JIS B2238 bolt hole pattern

**An optional purging system can be installed between the flange and the horn antenna. See page 13 for Air Purging information.

SITRANS LR400 (7ML5421 version) with optional Temperature Extension

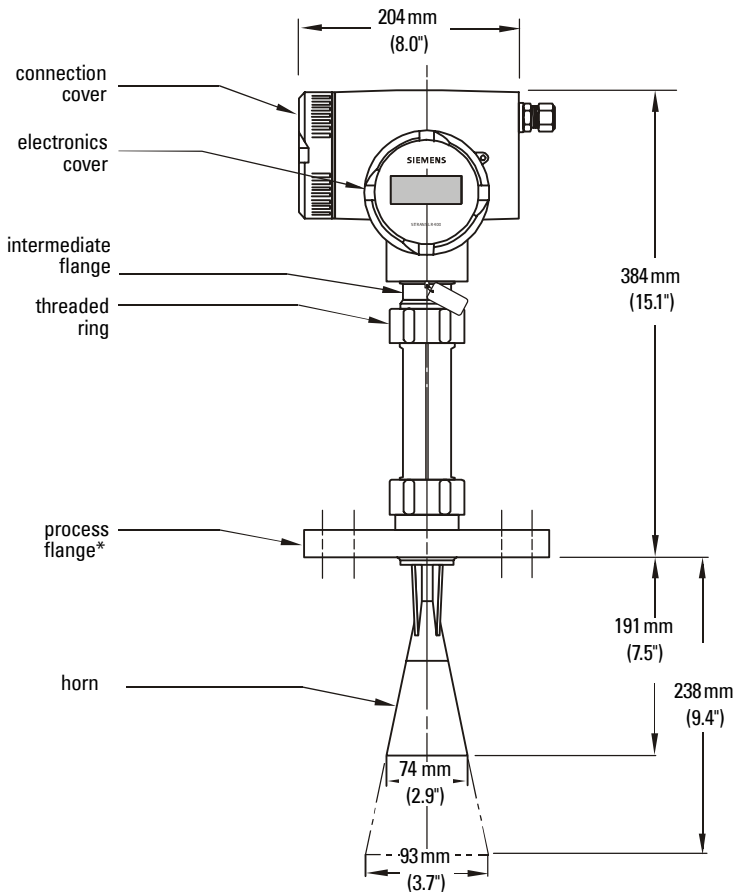

*Flange according to DIN 2527 / ANSI B 16.5 / JIS B2238 bolt hole pattern

Note: Process temperature and pressure capabilities are dependent upon information on the process device tag. See Appendix IV (Process Pressure/Temperature de-Rating). Reference drawing listed on the tag is available upon request.

! **WARNING:** The user is responsible for the selection of bolting and gasket materials which will fall within the limits of the flange and its intended use and which are suitable for the service conditions.

DIN / JIS Flat Face Flange Diagram (7ML5421 version only)

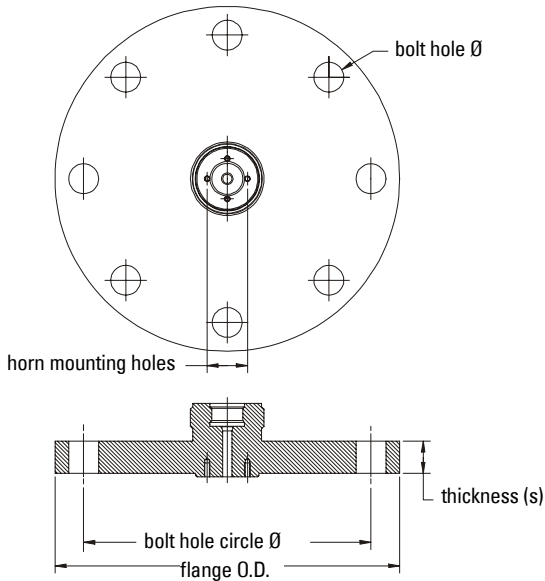

Flange according to DIN 2527 (see Flange Diagram above)

Pipe Size	Flange Size	Flange O.D.	Thickness (s)	Bolt Hole Circle Ø	Bolt Hole Ø	Number of Bolts
80 mm	PN 16	200 mm	20.0 mm	160 mm	18.0 mm	8
100 mm	PN16	220 mm	20.0 mm	180 mm	18.0 mm	8
150 mm	PN 16	285 mm	22.0 mm	240 mm	22.0 mm	8
80 mm	PN 40	200 mm	24.0 mm	160 mm	18.0 mm	8
100 mm	PN 40	235 mm	24.0 mm	190 mm	22.0 mm	8
150 mm	PN 40	300 mm	28.0 mm	250 mm	26.0 mm	8

Flange according to JIS B 2238

Pipe Size	Flange Size	Flange O.D.	Thickness (s)	Bolt Hole Circle Ø	Bolt Hole Ø	Number of Bolts
80 mm	10 K	185 mm	20.0 mm	150 mm	19.0 mm	8
100 mm	10 K	210 mm	22.0 mm	175 mm	19.0 mm	8
150 mm	10 k	280 mm	24.0 mm	240 mm	23.0 mm	8

Note: Process temperature and pressure capabilities are dependent upon information on the process device tag. See Appendix IV (Process Pressure/ Temperature de-Rating). Reference drawing listed on the tag is available upon request.

! **WARNING:** The user is responsible for the selection of bolting and gasket materials which will fall within the limits of the flange and its intended use and which are suitable for the service conditions.

ANSI Raised Face Flange Diagram (7ML5421 version only)

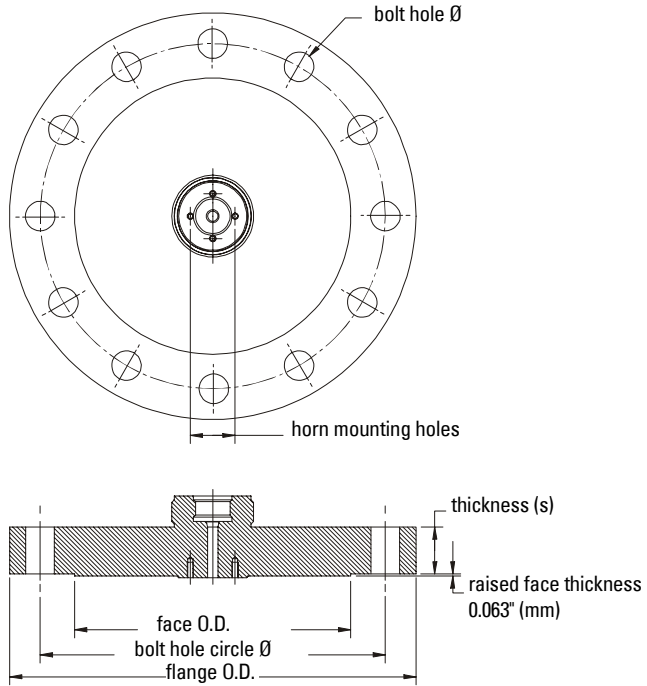

Flange according to ANSI B 16.5 (see Flange Diagram above)

Pipe Size	Flange Size	Flange O.D.	Thickness (s)	Face O.D.	Bolt Hole Circle Ø	Bolt Hole Ø	Number of Bolts
3"	150 #	7.50"	0.941"	5.0"	6.00"	0.75"	4
4"	150 #	9.00"	0.941"	6.19"	7.50"	0.75"	8
6"	150 #	11.00"	1.00"	8.5"	9.50"	0.88"	8
3"	300 #	8.25"	1.12"	5.0"	6.62"	0.88"	8
4"	300 #	10.00"	1.25"	6.19"	7.88"	0.88"	8
6"	300 #	12.51"	1.44"	8.5"	10.62"	0.88"	12

Note: Process temperature and pressure capabilities are dependent upon information on the process device tag. See Appendix IV (Process Pressure/Temperature de-Rating). Reference drawing listed on the tag is available upon request.

! **WARNING:** The user is responsible for the selection of bolting and gasket materials which will fall within the limits of the flange and its intended use and which are suitable for the service conditions.

Air Purging System (Optional)

For more frequent cleaning, a purging system can be installed between the flange and the horn antenna. The system provides an 1/8" inlet (female thread) on the flange where cooling air or cleaning fluid passes through the flange and exits the inside of the horn to clean it. The customer will supply the purging medium by manual or automatic valve system. This option is only available with universal flange for purging shown on page 14.

Notes:

- The Air Purge feature should not be activated with a dust cap in place.
- Purge duration, pressure, and interval, will vary with each application. It is the user's responsibility to determine the requirements depending on the application and cleaning required.
- Short duration bursts of high pressure provide more effective cleaning than continuous low pressure air.
- Some dust particles are highly abrasive and can be drawn into the inside of the horn during purge cleaning, damaging the internal PTFE emitter of the antenna. A replacement kit is available from your local Siemens Milltronics representative.
- It is the customer's responsibility to ensure that any vacuum or pressure in the measured vessel is maintained, considering the hole that passes through the process connection and SITRANS LR400 antenna system.

**Air Consumption
(Flowrate versus applied pressure)**

Air Pressure	Approximate inlet volume flow rate (standard cubic feet/minute)
20	5 SCFM
40	6 SCFM
60	8 SCFM
80	9 SCFM
90	10 SCFM

Universal Slotted Flange Diagram (for use with Air Purging Option only)

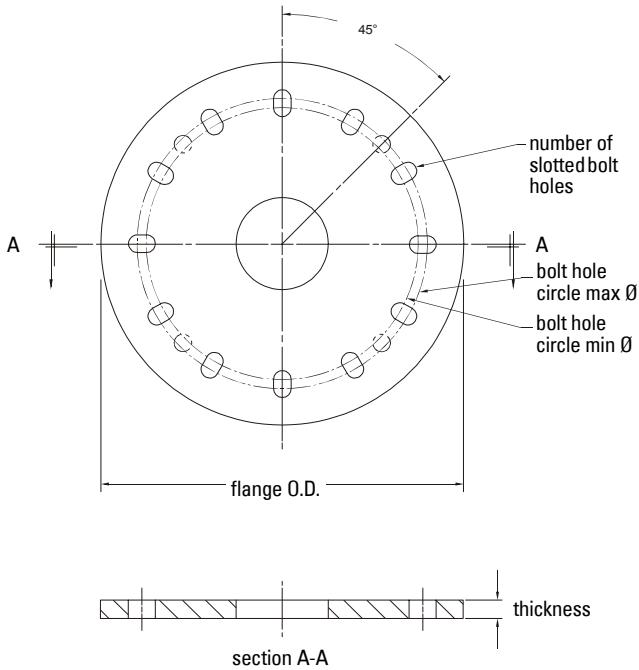

Flange according to Universal Slotted Flange (see Flange Diagram above)

Pipe Size	Flange O.D.	Thick-ness (s)	Bolt Hole Circle Max Ø	Bolt Hole Circle Min Ø	Bolt Hole radius	Number of Slotted Holes
3" or 80 mm	7.87"	0.40"	6.30"	5.90"	0.38"	8
4" or 100 mm	9.00"	0.40"	7.50"	6.89"	0.38"	8
6" or 150 mm	11.22"	0.40"	9.50"	9.44"	0.45"	8
8" or 200 mm	13.5"	0.40"	11.75"	11.4"	0.45"	12

! **WARNING:** The user is responsible for the selection of bolting and gasket materials which will fall within the limits of the flange and its intended use and which are suitable for the service conditions.

Installation

Notes:

- SITRANS LR400 is rated for Type 4X/NEMA 4X, Type 6/NEMA 6, IP67. Follow all installation and operating instructions to meet the requirements of this type of protection. Use only approved, suitable sized hubs for watertight applications.
- Observe all maximum permissible ambient and process temperatures. Refer to Appendix III (Ambient/Operating Temperature Specification). Provide a warning sign and/or touch guard if the surface of the measuring instrument can become hotter than 70 °C (158 °F) in use.



WARNINGS:

- This product is designated as a Pressure Accessory per directive 97/23/EC and is not intended for use as a safety device.
- Improper installation may result in loss of process pressure.

Mounting Location

Recommendations

- Position device with easy access for viewing display and programming via handheld programmer.
- Mount device in an environment suitable to the housing rating and the materials of construction.
- Mount the unit more than 1 m away from the vessel walls, pipes and other assemblies as well as the filling stream, because all these influences will become noticeable as reflective interference. Align the antenna so that the radar cone intersects the surface of the measuring medium as vertically as possible.

Precautions

- Do not mount in direct sunlight without the use of a sun shield.

Warning: Internal temperature must not exceed 85 °C (185 °F)!

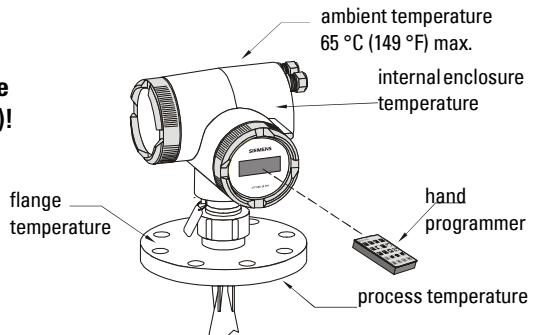

- Avoid proximity to high voltage or current wiring, high voltage or current contacts, and to variable frequency motor speed controllers.
- Avoid interference to emission cone from obstructions or from fill path.
- Avoid central locations on vesse

! **WARNING: For vessels with conical or parabolic tops, avoid mounting the unit at the center.** The concavity of the top can focus echoes into the centre, giving false readings.

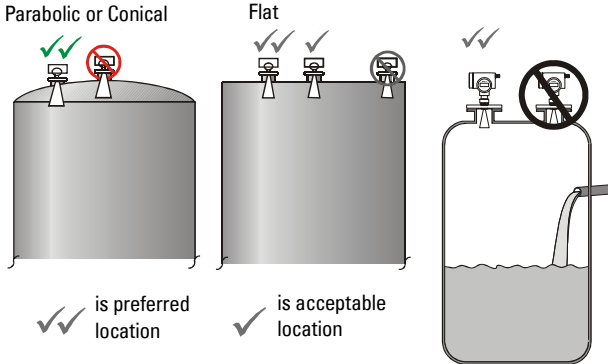

Beam Width

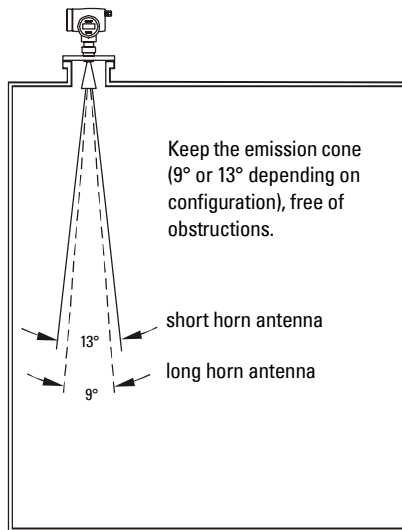

Correct Installation in Mounting Nozzle

The bottom edge of the antenna must project into the vessel to avoid reflective interference at the wall of the nozzle. Above flange size DN 150/6", the antenna need not project beyond the nozzle unless the radiation cone (the extension of the antenna's angle) touches the nozzle wall.

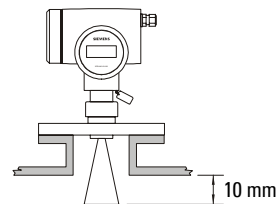

Electrical Connection

Notes:

- The equipment must be protected by a 15A fuse or circuit breaker in the building installation.
- A circuit breaker or switch in the building installation, marked as the disconnect switch, shall be in close proximity to the equipment and within easy reach of the operator.

WARNING:

- ! All field wiring must have insulation suitable for at least 250 V.

AC version:

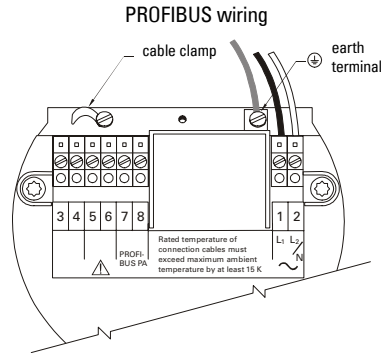
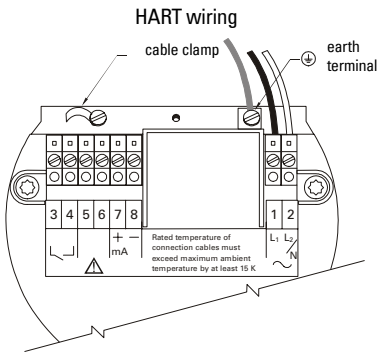

DC version:

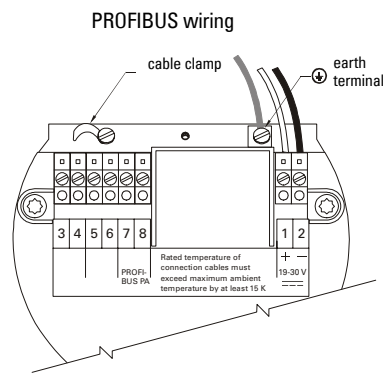
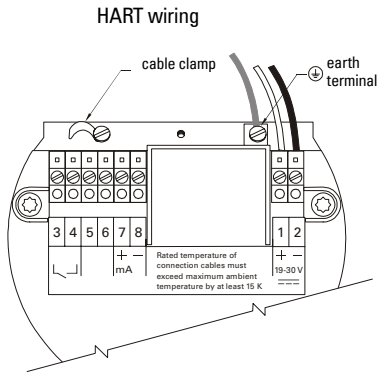

- The DC input terminals shall be supplied from a source providing electrical isolation between the input and output, in order to meet the applicable safety requirements of IEC 61010-1

Notes (AC and DC versions):

- 4-20 mA, PROFIBUS PA, DC input circuits, 14 - 20 AWG, shielded copper wire
- AC input circuit, min 14 AWG copper wire
- Recommended torque on terminal clamping screws, 0.5 - 0.6 Nm.

Connecting the SITRANS LR400:

1. Release the cover lock on the connection box with a 3 mm Allen key.
2. Unscrew the cover from the connection box.
3. Push the power cable and signal cable through the cable gland on the right of the unit, up to the terminal strip. Lay the cable in a bend before the cable gland so that moisture cannot enter the connection box.
4. Connect the earth conductor of the power supply to the earth terminal  in the connection box. Adjust the cable length so that the earth conductor would be last to disconnect last if cable is pulled.
5. In devices with ignition protection types II 1/2G EEx dem [ia] IIC T6 and II 1/2G EEx dem [ib] IIC T6 or II 2G EEx dem [ia] IIC T6 and II 2G EEx dem [ib] IIC T6 (7ML5421 version), mount the cover for the power supply terminals.
6. Tighten the cable screw gland and check the strain relief (pull and turn).
7. In devices with ignition protection type II 1/2G EEx D IIC T6 or II 2G EEx d IIC T6 (7ML5421 version), replace unused screw-type cable glands with a certified dummy plug.
8. Screw the cover onto the housing and tighten it without using a tool. The sealing ring must be clean and undamaged.
9. Mount the cover lock of the connection box cover.
10. Connect the earth terminal located between the screw-type cable glands to a ground connection at your vessel by using a cable of a cross-section at least 2.5 mm².

For error-free communication via the HART protocol, a load of at least 230 Ω must be available in the signal circuit.



WARNINGS:

- To avoid short-circuits, do not connect a load resistance with bare wires in the connection box.
- The housing cover may not be unscrewed in a hazardous area when the device is under voltage (power supply, digital outputs on external supply).
- In devices with ignition protection types II 1/2G EEx dem [ia] IIC T6 and II 1/2G EEx dem [ib] IIC T6 II 2G EEx dem [ia] IIC T6 and II 2G EEx dem [ib] IIC T6 (7ML5421 version), only the cover of the connection box may be unscrewed for test purposes. The cover on the power supply terminals may not be removed!

Start Up

Self-test

When power is supplied, the device performs a self-test. Then, when the multi-display appears, the device is ready for programming.

Note: Frequent switching off and on of the device causes aging of the electronics (monitored using Parameter 3.1).

Multi-display

The multi-display shows on the LCD after a successful self-test with the first line showing level output and the second line showing signal-to-noise ratio (factory setting):

+	1	2	.	3	0	0		m									
+	3	0		d	b												

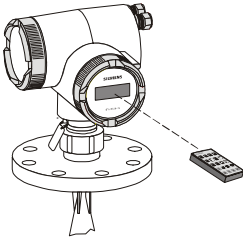

Local Programming

When the multi-display appears on the LCD, begin local programming using the hand programmer. To access the parameter settings, press LEFT  once. Main Menu is visible as the first LCD line. Then program the unit beginning with the Auto-Setup parameters.

Auto-Setup

After switching on the SITRANS LR400, and after a successful self test, press LEFT  to access the parameters. Set the Auto-Setup parameters to make the system operational: (see page 27)

- The language of the local user interface
- The unit of length of the measured level
- The nozzle height in the selected unit of length
- The vessel height in the selected unit of length
- The LRV (lower range value) as a distance from the bottom of the vessel
- The URV (upper range value) as a distance from the bottom of the vessel
- The damping of the measured level in seconds
- The application type
- The bus address by PROFIBUS PA communication (on PROFIBUS models)

Enter the necessary values as described in Parameters on page 26.

Note: It is strongly recommended that a Customer Code (Parameter 5.2) be entered after all programming is completed to secure the programmed values from changes.

If the multi-display does not appear or displays incorrect measured values after Auto-Setup, proceed as described in Troubleshooting on page 81.

Refer to the *Parameter* section that begins on page 26 for a list of available parameters.

Operation

General Information

You can operate SITRANS LR400 with:

- Handheld infrared programmer
- Handheld HART Communicator
- PC/Laptop and SIMATIC PDM software via HART or PROFIBUS PA

Notes:

- SITRANS LR400 can be operated and programmed easily with SIMATIC PDM software. This software gives you the added possibility of saving and archiving your application-specific parameters and copying them back into the device if necessary.
- It is best to perform the operations described in the following sections directly on the device to familiarize yourself with the operation.

Operating SITRANS LR400

Use the arrow keys at the bottom of the hand programmer to program SITRANS LR400. The two-line LCD displays the parameters. You can alter the setting or change to other parameters using the arrows on the hand programmer (see page 22 for information on navigating the menus using the arrow keys).

Hand Programmer

Note: The ARROW buttons shown below are required for programming this product. The additional buttons on the hand programmer do not apply to SITRANS LR400.







Key	Programming Mode
	Parameter scroll UP
	Parameter scroll DOWN
	LEFT Arrow (or CANCEL)
	RIGHT Arrow (or ENTER)

Selecting a Parameter

After a successful self-test, SITRANS LR400 displays the two-line multi-display.

Press LEFT ARROW  to access the parameter menus. The first line of the display shows the current parameter menu level. The second line shows one of the parameters you can access in the current parameter group.

Scroll through the parameters in the group by pressing UP  and DOWN . RIGHT  accesses the parameter displayed on the second line. LEFT  closes this parameter and moves up one level until you return to the multi-display.

When you select a parameter, its current value is displayed in the second line. When the cursor flashes, programming is enabled, (see Disabling and Enabling Programming on page 23) and you can change the current setting. If the parameter is display only or if programming is disabled, the cursor will not flash.

Note: The background illumination of the LCD switches on when the hand programmer is used for programming. It goes out about three minutes after last button press.

Structure of Parameters

Operation is hierarchically structured: the parameters are arranged in groups and assigned a numerical menu identification (see example below from a HART device).

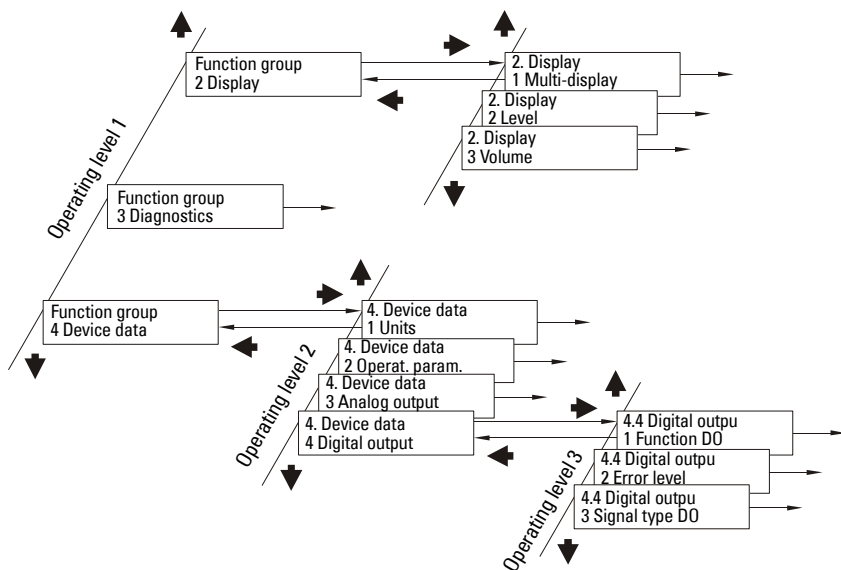





Changing a Parameter Value

Selecting a Parameter Value from a List





In many cases, you can assign a parameter a value from a list of options.

You will see a single entry of the possible choices in the second display line.



- Press UP  or DOWN  to cycle through the list and choose the desired entry. Press RIGHT  to assign the current entry to the parameter. The device accepts the new setting, closes the input and returns to the next parameter level up.
- LEFT  operates like a CANCEL key: When pressed, the device closes the parameter input but keeps the originally displayed value. It does not save a changed setting!

For an example of assigning a value from a selection list, see *Parameter Operating Examples* on page 24.

Functions of Hand Programmer Keys



- 
 - Changes display from RUN mode to PROGRAM mode
 - Operates as a CANCEL key when programming input position is at the far left
 - Moves input position to the left during PROGRAM mode
- 
 - Operates as an ENTER key when input position is at the far right. If the input value is not within the permissible input range. Then an error message is displayed.
 - Moves input position to the right during PROGRAM mode
-  
 - Changes input variable up or down

Top or bottom of representable range



If you press UP  when the value is at the top of the representable range, SITRANS LR400 automatically places the value at the next highest position. If 0.9 is displayed and you press UP , the value becomes 1.0. So, 9 becomes 10, 90 or 99 become 100 (depending on whether you have set the input position to the second or first 9), etc.

This input system also works in the opposite direction: For example, when 100 is displayed and you press DOWN  on the first or second 0, the numeric value changes to 90 or 99 and the device cancels the places in front of the decimal point.

Decimal point

You can also set the cursor to the decimal point (unless an integer value is currently displayed). UP  or DOWN  will then multiply or divide the displayed value by 10. The necessary additional places in front of the decimal point appear. You cannot change the number of displayed decimal places.

Display scrolling

Displayed text may be longer than the field of the display. An arrow pointing outward on the right or left hand side of the display line indicates that the text continues outside the multi-display. You can read the additional text using RIGHT  and LEFT  to move the pointer past the end of the line.

See *Parameter Operating Examples* on page 24 for an example of manual input.

Disabling and Enabling Programming

To prevent unauthorized personnel causing programming errors using the display module, set a customer code – a personal, number code up to 9 digits. A device protected by a customer code still displays all functions and values but it requests input of the code before resetting a parameter.

Note: The customer code is activated 10 minutes after you have programmed Parameter 5.2 Customer Code.

Programming is enabled when you:

- enter the requested customer code for the current parameter
or
- release the programming lock using Parameter 5.1 Code Input on page 56.

The programming lock will be released for approximately 10 minutes. Any other code number locks and disables programming.

When you return to the multi-display or enter a number in the Code Input parameter which is different from the customer code, or do not operate the device for 10 minutes, the programming lock is enabled.

Note: If Customer Code (Parameter 5.2) is 0, programming of parameters is always enabled. We strongly recommend that a customer code be entered after all programming is completed to secure the programmed values from change.

Parameter Operating Examples

Example (HART): Change the length unit from m to mm.

The example begins at the multi-display (1). Follow the bold arrowed path to complete the task. Use the arrow buttons shown next to the numbered operation steps.

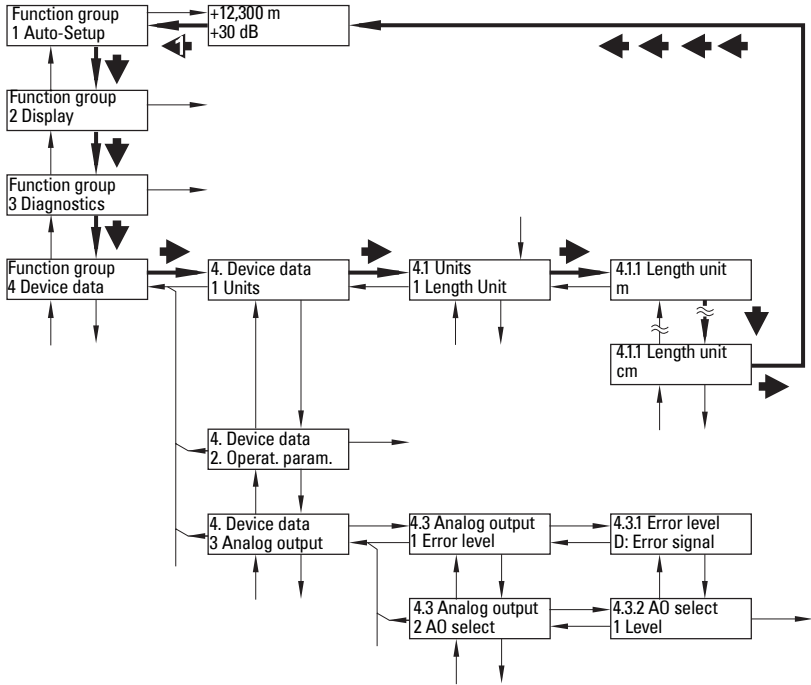



Example 2: Change the filling speed from 2.0 cm/min to 100 cm/min.

Access the **Fill speed** parameter from the multi-display according to instructions on page 22.

The default setting appears in the display.

Enable the programming by pressing RIGHT . The second segment of the second display line flashes.

Set the digit to 1 with DOWN .

Select the decimal point with RIGHT .

Press UP  twice so that two other places appear in front of the decimal point.

Select the last decimal place with RIGHT .

End the input with RIGHT  (ENTER).

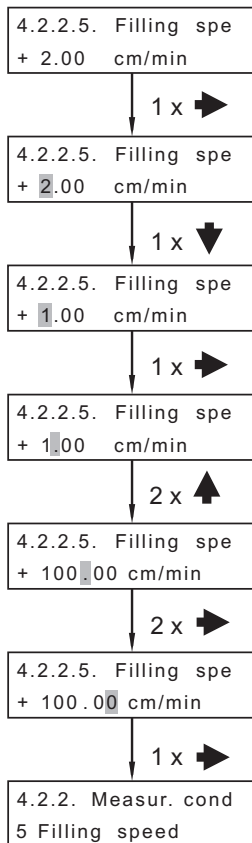

Parameters (HART)

The parameter groups are followed by the parameters within each group. The parameter tables show the values you need to enter and are followed by additional information when necessary. Factory settings are displayed after the parameter name, where applicable.

Note: Parameter menus are dependent on selections made by the user. In some cases, parameter menus are renumbered according to the selection made at the previous menu level. See table below for an example.

When User chooses Parameter 4.2.2.1: Application Type = Liquids (Process)	When User chooses Parameter 4.2.2.1: Application Type = User tank1
4.2.2.2: Surface	(not available when 4.2.2.1 = User tank1)
4.2.2.3: Dead band	4.2.2.2: Dead band
4.2.2.4: Correction Factor	4.2.2.3: Correction Factor
4.2.2.5: Filling Speed	(not available when 4.2.2.1 = User tank1)
4.2.2.6: Reflectivity	(not available when 4.2.2.1 = User tank1)
4.2.2.7: Failsafe Level	4.2.2.4: Failsafe Level
4.2.2.8: Failsafe Timer	4.2.2.5: Failsafe Timer
4.2.2.9: Range Extension	4.2.2.6: Range Extension

Default values are indicated as "F=" following the parameter number and name.

Vessel Functional Dimensions

1. Nozzle height
2. Dead band
3. Raw value (measured)
4. Level (=calculated value)
5. Lower range value (LRV)
6. Lower limit
7. Upper limit
8. Upper range value (URV)
9. Vessel height

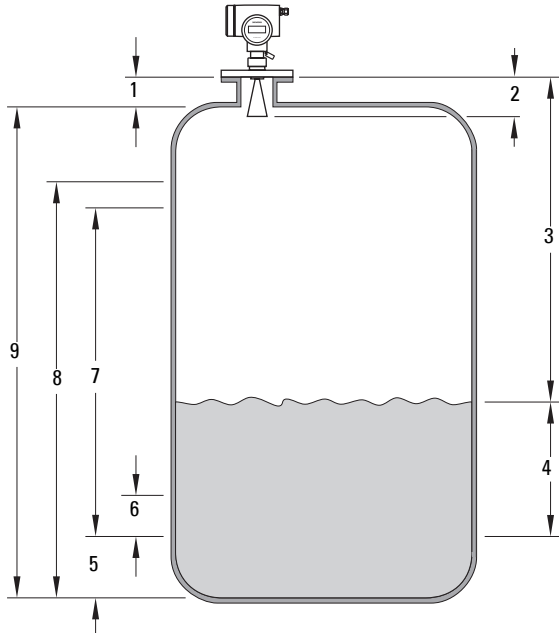

Parameters (HART)

Required Parameters

Note: The following parameters are absolutely essential for proper operation of the device. They apply to all applications and are required to make the system operational.

1. Auto-Setup

1.1 Language Local (F = English)

Selects the language to be used on the LCD

Value	English
	Deutsch

1.2 Length Unit (F = m)

Specifies measurement units used for dimensional values

Value	cm
	m
	mm
	ft
	in

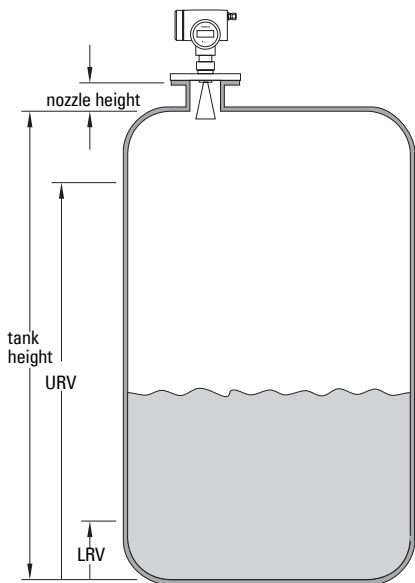

current of 20 mA.

1.3: Nozzle Height (F = 0 m)

Specifies length of nozzle from top of device flange to top of vessel

Value	numerical value
-------	-----------------

1.4: Tank Height (F = 20 m)

Specifies height of vessel from nozzle bottom to vessel bottom

Value	numerical value
-------	-----------------

1.5: Level URV (F = 20 m)

Sets full scale of level

Value	numerical value
-------	-----------------

Set the URV as the level above the bottom of the vessel in the units selected with Parameter 4.1.1. It corresponds to an output

1.6 Level LRV (F = 0 m)

Sets the distance from the bottom of the vessel to the empty level.

Value	numerical value
-------	-----------------

Set the LRV as the level above the bottom of the vessel in the units selected with Parameter 4.1.1. It corresponds to an output current of 4 mA.

1.7 Level damping (F = 1 s)

Sets the damping of the level value in seconds

Value	numerical value
-------	-----------------

The damping acts on the analog output, the limit value monitor and the local display. For damping of the sensor signal, set Parameter 4.2.3.1.

1.8 Application Type (F - Liquid [process])

Sets the use of the vessel

Value	Liquid (store) [7ML5421 version]
	Liquid (process) [7ML5421 version]
	Silo1 (solids) [solids with high reflectivity]
	Silo2 (solids) [solids with low reflectivity]
	User tank1
	User tank2

Select Silo1 (solids) for solids with high reflectivity. Select Silo2 (solids) for solids with low reflectivity, typically used for cement. In most cases, you set one of the pre-specified applications. User vessels can be programmed using special configurations that deviate from the factory specified models. They are designed for special applications loaded at the factory or by trained service personnel.

Note: The following parameters cannot be accessed when you set a user vessel (User tank1 or User tank2):

- Parameter 4.2.2.2 (Surface)
- Parameter 4.2.2.5 (Filling Speed)
- Parameter 4.2.2.6 (Reflectivity)
- Sensor Parameters 4.2.3.1 (Sensor Damping)
- 4.2.3.2 (Multiple Echoes)
- 4.2.3.3 (Echo Motion)
- 4.2.3.4 (Window Tracking)
- 4.2.3.5 (Tank Empty Detect)

The parameters that remain under 4.2.2.x will be renumbered. See page 26 for more information on parameter renumbering.

Additional Parameters

2. Display

2.1 Multi-display (F = level in m Signal to noise ratio in db)

Two-line display shows two measured values. The values to be shown are set using Parameter 4.5.1.1 (Line 1 Local) and in Parameter 4.5.1.4 (Line 2 Local).

2.2 Level (F = m)

Current level of material (set unit using Length Unit in Auto-Setup)

2.3 Volume (F = m³)

Volume of material (set unit using Parameter 4.1.2 [Volume Unit])

2.4 Mass (for qualified personnel only)

This parameter is for Factory Authorized Personnel only.

2.5 Current Output

Analog output displayed in mA

When the device electronics are working properly, the displayed mA current value will correspond to the measured output current.

2.6 Digital Output

State of digital output

3. Diagnostics

3.1 Status

The Status parameters display the current status messages of the device. Parameter 3.1.1 is always accessible; other parameters (Parameter 3.1.x) appear in the appropriate order if they contain error messages.

3.1.1 Wear

3.1.1.1: Operating Hours

Total previous operating time of the device in hours (approximate value)

3.1.1.2 Maximum Temperature (F = 26 °C)

Last recorded maximum internal temperature of the device

Note: This temperature must not exceed 85 °C (185 °F) or warranty may be void.

3.1.1.3 Minimum Temperature (F = 26 °C)

Last recorded minimum internal temperature of the device

3.1.1.4 Aging

Approximate value for the prior life of the device in % (100% = approx. 10 years)

This parameter outputs a calculated percentage which estimates the wear of the device due to aging.

3.1.1.5 Hours > 85 °C

Total time the maximum permissible internal temperature (85 °C) was exceeded, in hours

3.1.x Sensor, electronics, software, application, parameters, service

These parameters are only displayed if they contain an error message. The number of the menu items matches the number of defective functions and can range in extreme cases from 3.1.2 to 3.1.7.

See *Troubleshooting* on page 81 for the individual error messages and possible remedies.

3.1.x Sensor

Diagnostic messages of the sensor

and/or

3.1.x Electronics

Diagnostic messages of the electronics

and/or

3.1.x Software

Diagnostic messages of the software

and/or

3.1.x Application

Diagnostic messages regarding the application

and/or

3.1.x Parameters

Display any of non-compatible programmed parameters

and/or

3.1.x Service MC

For factory service purposes only

3.1.x Service DSP

For factory service purposes only

3.2 Device Test

3.2.1 Self-test

Check device state

The device integrates the self-test routines in the ongoing measurements; it completes them after approximately 10 seconds. A successful self-test is confirmed with the display . The display signals an error. View Parameter 3.1.x to determine the error type.

3.2.2 Display test

Visual test of LCD

During the LCD test, the display is blank for five seconds and then illuminates for another five seconds so that you can determine whether individual display points have failed.

3.3 Simulation

This parameter can support testing the correct functions of the mA connections during commissioning or maintenance of the device. With the two parameters, you can temporarily replace the measured values at the analog and digital output with known simulated output values.

Note: The Simulation parameter influences output to the control system.

3.3.1 Simulate AO (F = 4 mA)

Simulation of the analog output signal

Value	4 mA
	10 mA
	12 mA
	20 mA
	Error signal

When a value is entered in this parameter, the current value to be validated is defined.

Complete the parameter entry by pressing LEFT so the analog output again gives the measured value.

3.3.2 Simulate DO (F = End)

Simulation of the digital output signal

Value	Relay on
	Relay off
	End

Select the applied output value (relay on or relay off).

Complete the parameter entry by pressing LEFT  so the digital output again gives an alarm/limit.

3.3.3 Error Simulation for Micro Controller High Word

For factory service purposes only

3.3.4 Error Simulation for Micro Controller Low Word

For factory service purposes only

3.3.5 Error Simulation for DSP Controller High Word

For factory service purposes only

3.3.6 Error Simulation for DSP Controller Low Word

For factory service purposes only

3.4 Sensor Variables

You can read out internal device data with this parameter group. The displayed values depend on the respective application. You can access the following data:

3.4.1 Raw Value (for service purposes only)

Distance from the flange to material

The measured distance from the flange to the surface of the material.

3.4.2 Echo Amplitude

Measure of quality of reflection

This dimensionless value is an absolute measure of the strength of reflection at the material. Its display can be evaluated as follows:

- $x > 1$: very good
- $1 > x > 0.5$: good
- $0.5 > x > 0.05$: satisfactory
- $x < 0.05$: uncertain

3.4.3 S/N Ratio

Signal-to-noise ratio of the measured value in dB

S/N ratio provides a relative measure of the strength of reflection of the material in dB. Its display can be evaluated as follows:

- **x > 20:** very good
- **20 > x > 10:** good
- **x < 10:** satisfactory

3.4.4 Validity

Validity of the measured value in %

This parameter provides a percentage measure of the certainty that the displayed measured value corresponds to the real level and does not represent a multiple echo or a fixed target. Its display can be evaluated as follows:

- **x > 70:** very good
- **70 > x > 50:** good
- **50 > x > 20:** uncertain
- **x < 20:** no plausible measured value

3.4.5 Sensor Temp

Internal electronics sensor temperature

4. Device Data

4.1 Units

4.1.1 Length Unit = Parameter 1.2

4.1.2 Volume unit (F = m³)

Specifies volume units used for dimensional values

Value	bbl
	yd ³
	ft ³
	in ³
	bush
	bbl (liq)
	l
	m ³
	hL
	Gal
	ImpGal

4.1.3 Mass Unit (F = kg)

Specifies mass units used for dimensional values

Value	kg
	Ton
	lb
	LTon
	STon

4.1.4 Temperature Unit (F = °C)

Unit of the internal electronics sensor temperature

Value	°C
	°F
	K

4.1.5 Other units (F = SI)

Units system for all other units

Value	SI unit
	US/UK unit

With this function, determine whether you want to enter the operating parameters (see Parameter 4.2) in SI or in British Imperial (US/UK) units. The selected units of the measured value output and sensor temperature as well as the decimal point are not influenced by this setting.

4.2 Operating Parameters

With these parameters, you will define the dimensions of your vessel, the type of measuring material and the calculation of the measured signal. Signal-specific default settings such as the failure signal or the upper current limit of the analog output signal are assigned to the functions of the respective outputs (see Parameters 4.3 and 4.4).

4.2.1 Tank Geometry

4.2.1.1 Nozzle Height = Parameter 1.3

4.2.1.2 Tank Height = Parameter 1.4

4.2.1.3 Stilling Pipe? (F = no) [7ML5421 version]

Stilling pipe available?

Value	Yes
	No

By selecting **yes** or **no**, you specify whether the device is mounted on a stilling pipe. If you select **yes**, Parameter 4.2.1.3.2 is enabled so you can specify the internal diameter of the stilling pipe.

4.2.1.3.2 Pipe Diameter (F = 100 mm) [7ML5421 version]

Internal diameter of the stilling pipe

Value	numerical value
--------------	-----------------

4.2.2 Measuring Conditions

4.2.2.1 Application Type (F - Liquid [process])

Use of the vessel

Value	Liquid (store) [7ML5421 version]
	Liquid (process) [7ML5421 version]
	Silo1 (solids)
	Silo2 (solids)
	User tank1
	User tank2

Select Silo1 (solids) for solids that have high reflectivity. Select Silo2 (solids) for solids with low reflectivity, typically used for cement. In most cases, you set one of the pre-specified applications. User vessels can be programmed using special configurations that deviate from the factory specified models. They are designed for special applications loaded at the factory or by trained service personnel.

Note: The following parameters cannot be accessed when you set a user vessel (User tank1 or User tank2):

- Parameter 4.2.2.2 (Surface)
- Parameter 4.2.2.5 (Filling Speed)
- Parameter 4.2.2.6 (Reflectivity)
- Sensor Parameters 4.2.3.1 (Sensor Damping)
- 4.2.3.2 (Multiple Echoes)
- 4.2.3.3 (Echo Motion)
- 4.2.3.4 (Window Tracking)
- 4.2.3.5 (Tank Empty Detect)

The parameters that remain under 4.2.2.x will be renumbered. See page 26 for more information on parameter renumbering.

4.2.2.2 Surface (F = wavy)

Surface structure of the material. Not displayed if a user vessel is selected in Parameter 4.2.2.1.

Value	Smooth
	Wavy
	Turbulent

This parameter is not displayed when a user vessel is selected in Parameter 4.2.2.1.

When used with poorly reflecting measuring media, you may be able to improve measuring results by setting a different surface structure here. If your measuring medium forms waves more than 1 cm in height, you should select the **wavy** setting. The turbulent setting is recommended for waves greater than 10 cm.

4.2.2.3 Dead band (F = 0.35 m)

Defines the distance from below the flange to be ignored by the transmitter/receiver

Value	numerical value, Minimum value = Length of the antenna
-------	--

Specification of a dead band in the units system selected according to Parameter 4.1.5 defines a minimum distance from the flange which the measuring medium must have for the device to accept the measured values as valid. This suppresses reflective interference generated by the nozzle, close obstacles, or the antenna. For solids applications, a dead band setting of 1 m minimum is recommended.

Note: The dead band must exceed the antenna's length.

4.2.2.4 Correction Factor (F = 1.0)

Correction factor for physical measuring influences. Generally only applies to liquid applications using a stilling well.

Value	numerical value
-------	-----------------

The propagation time of the microwaves between the antenna and the measuring medium changes slightly depending on the pressure inside the vessel. If this pressure is constant, however, it can be included in the evaluation according to the equation:

$$K = \frac{1}{\sqrt{1 + (\varepsilon_{r, Gas} - 1) \cdot \frac{273 \cdot p}{T_{Gas} + 273}}}$$

K = correction factor, p = pressure inside the vessel in bar, T_{gas} = gas temperature in °C, ε_{r, Gas} = dielectric of the overlying gas, e.g. ε_{p, air} = 1.00059

Enter the correction factor *K* as a dimensionless value.

4.2.2.5 Filling Speed (F = 200 mm/min)

Typical speed of change of the level. Not displayed if user vessel is selected in Parameter 4.2.2.1 (Application Type).

Value	numerical value
--------------	-----------------

This parameter is not displayed when a user vessel is selected in Parameter 4.2.2.1. When you determine that the displayed measured value does not follow the change in the height of the level in the vessel, you can enter a value for the speed with which it generally changes. This assigns a greater probability to measuring targets which move at this speed.

If the display does not follow the level height continuously but in abrupt jumps, you should choose a higher filling speed. If multiple echoes are indicated during filling/emptying a vessel, select a lower filling speed. In the case of very low filling speeds (a few mm/min) switch off Parameter 4.2.3.3. If different filling/emptying speeds occur, select the higher speed.

4.2.2.6 Reflectivity (for qualified personnel only)

This parameter is for Factory Authorized Personnel only.

This parameter is not displayed when a user vessel is selected in Parameter 4.2.2.1.

4.2.2.7 Failsafe Level (F = Hold Continuously)

Selects the default measurement in the event that the failsafe timer (P 4.2.2.8) expires

Value	100 %
	0 %
	Hold Continuously

4.2.2.8 Failsafe Timer (F = 10 min)

Sets the time delay, in minutes, before entering failsafe level

Value	1 min
	2 min, etc.

The failsafe timer begins when there is a loss of echo condition. This loss of echo condition will occur when there is no signal available above the Auto False-Echo Suppression threshold as defined in Parameter 4.2.3.9.

4.2.2.9 Range Extension (F = 3 m)

Sets the range extension as measured from the vessel height and extending beyond the measurement range. For vessels with conical or parabolic bottoms, you may need to increase this value to ensure an empty vessel reads empty.

Value	numerical
--------------	-----------

4.2.3 Sensor Parameter

View and change the sensor parameters you have selected according to Parameter 4.2.2 (Measuring Conditions).

Note: The factory settings for the user vessels are not editable.

4.2.3.1 Sensor Damping (F = 1 s)

Averaging of measuring signal. Not displayed if a user vessel is selected in Parameter 4.2.2.1 (Application Type).

Value	numerical
--------------	-----------

Enter damping in seconds.

This parameter is not displayed when a user vessel is selected in Parameter 4.2.2.1 (Application Type). The sensor damping influences the evaluation of the measuring signal. If the level generally only changes slowly and continuously, a time constant set here can improve the measuring accuracy and the validity in poorly reflecting measuring media or those with a restless surface. The sensor damping must always be smaller than the interval of the time of change of the level (e.g. 1 mm/10 s), because too high a value would have a negative influence on the measuring result.

Note: Specification of damping directly influences the evaluation of the measuring signal. If you only want to dampen the calculated outputs at the analog output, you should set the damping of level, volume or mass described in Function 4.2.4.4 (MinLim Level).

4.2.3.2 Multiple Echo (F = on)

Evaluate multiple echoes. The multiple echo evaluation suppresses multiple reflections by assigning them a lower probability than the measuring signal.

Value	On
	Off

This parameter is not displayed when a user vessel is selected in Parameter 4.2.2.1.

4.2.3.3 Echo Motion (F = off)

Evaluate echo motion

Value	On
	Off

This parameter is not displayed when a user vessel is selected in Parameter 4.2.2.1. Dynamic processes in the vessel are included in the evaluation of the measuring targets. The typical filling speed can be set in Parameter 4.2.2.5. If the measured value still does not follow the level height, switching off echo motion may improve the result.

4.2.3.4 Window Tracking (F = Off)

Value	On
	Off

This parameter is not displayed when a user vessel is selected in Parameter 4.2.2.1. A window follows the measured value which it is forced to track. The window size is calculated from the set filling speed. Switch off window tracking for applications where SITRANS LR400 is unable to keep up to level changes. By using SIMATIC PDM, you can display a list of all echoes in your vessel. It provides the distance between the flange and the measuring medium's surface, as well as the distances of fixed targets. These echoes may be directly used and transferred to the fix distance list.

4.2.3.5 Tank Empty Detect (for qualified personnel only)

This parameter is for Factory Authorized Personnel only.

This parameter is not displayed when a user vessel is selected in Parameter 4.2.2.1.

4.2.3.6 Auto Fix Distance (for qualified personnel only)

This parameter is for Factory Authorized Personnel only.

4.2.3.7 Fix Distance List (for qualified personnel only)

This parameter is for Factory Authorized Personnel only.

4.2.3.7.1 to 4.2.3.7.9 Fix Distance Values (for qualified personnel only)

These parameters are for Factory Authorized Personnel only

4.2.3.8 Auto False-Echo Suppression (F = Use)

Learns and records the current signal up to the suppression distance setting. These signals are then ignored during operation.

First, when the level is low, dip the vessel to determine the exact distance to the material. Then, set Auto False-Echo Suppression Distance (4.2.3.9) to 2 meters shorter than this dipped distance.

Note: This function works best when the vessel is nearly empty. For best results, do not record or learn when the vessel is completely empty.

Value	Off
	Record
	Use

If all signals fall below this defined threshold, then the failsafe timer is initiated.

4.2.3.9 Auto False-Echo Suppression Distance (F = 2/3 tank height)

Defines the end point of the auto false echo suppression distance.

Value	variable to maximum range
--------------	---------------------------

4.2.3.A Hover Level (F = 40%)

Defines (in percent) how high the TVT (Time Varying Threshold) curve is placed above the echo profile, relative to the largest echo. When SITRANS LR400 is located in the center of the vessel, lower the hover level to prevent multiple echo detections.

Values	Range: 0 to 100%
--------	------------------

4.2.3.B Window Trigger (F = 80%)

Defines the position of the window on the leading edge of the selected echo, relative to the amplitude. Used only on Silo1 and Silo2 applications (see Application Type on page 29).

Values	Range: 0 to 100%
--------	------------------

4.2.4 Level Parameter

4.2.4.1 Level URV (F = 20 m)

Full scale of level (see Vessel Functional Dimensions on page 27)

Value	numerical value
-------	-----------------

Set the URV as the full scale of level above the bottom of the vessel (see *Vessel Functional Dimensions* on page 27) in the units selected with Parameter 4.1.1. This level corresponds to an output current of 20 mA.

Note: This parameter is also set using Parameter 1.5 (Level URV).

4.2.4.2 Level LRV (F = 0 m)

Empty scale of level (see Vessel Functional Dimensions on page 27)

Value	numerical value
-------	-----------------

Set the LRV as the empty scale of level above the bottom of the vessel (see *Vessel Functional Dimensions* on page 27) in the units system selected with Parameter 4.1.1. It corresponds to an output current of 4 mA.

Note: This parameter is also set using Parameter 1.6 (Level LRV).

4.2.4.3 Level damping (F = 1 s)

Damping of level in s

Value	numerical value
--------------	-----------------

Set the damping of the level value in seconds. It acts on the analog output, the limit value monitor and the local display. For damping of the sensor signal, set Parameter 4.2.3.1.

Note: This parameter is also set using Parameter 1.7 (Level Damping).

4.2.4.4 MinLim Level (F = 0 m)

Lower limit value of the level (see Vessel Functional Dimensions on page 27)

Value	numerical value
--------------	-----------------

Set the lower limit value of the level as a height above the LRV.

4.2.4.5 MaxLim Level (F = 20 m)

Upper limit value of the level (see Vessel Functional Dimensions on page 27)

Value	numerical value
--------------	-----------------

Set the upper limit value of the level as a height above the LRV.

4.2.4.6 HYST Level (F = 0.5 m)

Hysteresis of the level limit values

Value	numerical value
--------------	-----------------

Set the hysteresis of the limit values in the units system selected according to Parameter 4.1.1 (see diagram below).

Limit value alarm

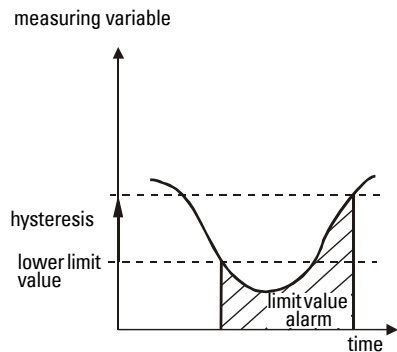
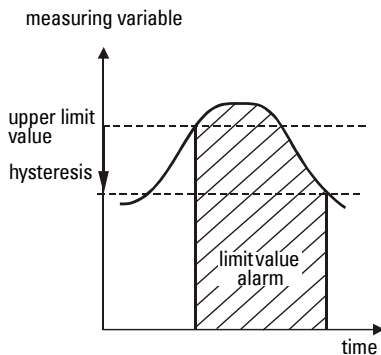

4.2.5 Volume Parameters

To calculate the volume of the measuring medium, you need the level parameters (Parameter 4.2.4) in the units selected according to Parameter 4.1.1 and tank characteristic (Parameter 4.2.5.7).

4.2.5.1 Volume URV (F = 20 m³)

Full scale of volume

Value	numerical value
--------------	-----------------

4.2.5.2 Volume LRV (F = 0 m³)

Empty scale of volume

Value	numerical value
--------------	-----------------

4.2.5.3 Volume Damping (F = 1 s)

Damping of volume

Value	numerical value
--------------	-----------------

4.2.5.4 MinLim Volume (F = 0 m³)

Lower limit value of volume

Value	numerical value
--------------	-----------------

4.2.5.5 MaxLim Volume (F = 20 m³)

Upper limit value of volume

Value	numerical value
--------------	-----------------

4.2.5.6 HYST Volume (F = 0.5 m³)

Hysteresis of the volume limit values

Value	numerical value
--------------	-----------------

4.2.5.7 Tank Characteristic (F = Calculate)

Determining the vessel characteristic

Value	Calibrate/table
	Calculate

Note: Select the option Calibrate/table or Calculate as required. The selection controls the display of Parameter 4.2.5.8. The choices for each parameter are listed below. For the values associated with Parameter 4.2.5.8: Calculate, go to page 46.

4.2.5.8 Calibrate/table

If your vessel deviates from the forms offered, the necessary data is not available or is unknown, or you need a vessel characteristic with greater accuracy, you will need to use a level/volume calibration table. You can enter reference values from a table provided by the vessel manufacturer or do the calibration manually and enter the determined reference values.





You can only enter pairs of values consisting of level and volume.

Note: Entering the vessel characteristic with the hand programmer can be a time-consuming procedure. It can be done more quickly and comfortably with the SIMATIC PDM software. There, an entered table can be edited – an option which is only conditionally possible with the hand programmer.

The 4.2.5.8 Calibrate/table parameter offers the following selection possibilities:

4.2.5.8.1 Calibrate

Here you can enter up to 50 reference values whose levels SITRANS LR400 measures.

1. Enter the appropriate volume (determined by manual calibration).
2. If you access this parameter, first the currently measured level is displayed. Accept it by pressing LEFT .
3. Enter the appropriate volume: save it by pressing RIGHT  or reject it by pressing LEFT .
4. Then the device displays **Calibrate**. Access again by pressing RIGHT  to select a further reference value. The device automatically offers you the next undefined reference value.

We recommend entering a maximum of two or three reference values for the linear range of the vessel and to use the others for the non-linear portion.

If you enter a second volume value for the same level, the reference value saved earlier is overwritten.

4.2.5.8.2 Enter table

Manual entry of a table

Value	numerical value
-------	-----------------

Here you can enter up to 50 reference values provided by the vessel manufacturer in any order.

The first reference value is offered when you access the parameter.

1. Enter the level as a distance from the floor of the vessel in the units selected according to Parameter 4.1.1 (Enter level) and the volume corresponding to the level (Enter volume).
2. The device then displays **Enter table** again. Access again to enter a further reference value. The device automatically offers you the next undefined reference value.

We recommend entering a maximum of two or three reference values for the linear range of the vessel. Use the other reference values for the non-linear section.

If you enter a second volume value for the same level, the reference value saved earlier is overwritten.

4.2.5.8.3 Show table

Display table

Value	selection
-------	-----------

Here you can display the entered reference values sorted on levels. In the second line, the level corresponding to the first reference value appears first and then the corresponding volume value when you switch further. Each switching accesses a further reference value.

4.2.5.8.4 Clear table

Delete table

Value	selection
-------	-----------

If you choose *all* in this parameter, the entire saved table is deleted. You can delete individual reference values with the selection **1st**, **2nd** etc. that were displayed in Parameter 4.2.5.8.3.

Note: The reference values are sorted in order of filling states and do not necessarily correspond to the order of the value pairs you have entered.

or

4.2.5.8 Calculate

Automatic calculation of a vessel characteristic is faster than manual entry by calibrating or a table. However, the calculated vessel characteristic is not as accurate as a manually calibrated characteristic – especially in the non-linear sections of the vessel when errors of $\leq 1\%$ may occur. As well, the necessary data which you can get from the design documents of your vessel must still correspond to the real conditions.

The 4.2.5.8: Calculate parameter requires the following parameters:

4.2.5.8.1 Tank Design (F = Vertical Cylinder)

Value	Linear
	Vertical cylinder
	Horizontal cylinder
	Sphere

Enter the external form of your vessel. You can choose from:

- Linear (any form with vertical walls and a flat floor)
- Vertical cylinder (vertically standing cylindrical form with curved covers)
- Horizontal cylinder (horizontal cylindrical form with curved caps)
- Sphere

4.2.5.8.2 Bottom Design (F = Dished end)

Value	Dished end
	Basket end
	Bullet bottom

Enter the form of the two vessel cover caps. You can choose from:

- Dished (according to DIN 28011)
- Basket (according to DIN 28013)
- Bullet (hemispherical shaped floor)

4.2.5.8.3 Tank volume (F = 20 m³)

Value	numerical value
--------------	-----------------

4.2.5.8.4 Tank height (F = 20 m)

Value	numerical value
--------------	-----------------

4.2.6 Mass Parameters (for qualified personnel only)

Mass parameters 4.2.6.1 to 4.2.6.9 are for Factory Authorized Personnel only.

4.2.6.1 Mass URV (for qualified personnel only)

4.2.6.2 Mass LRV (for qualified personnel only)

4.2.6.3 Mass Damping (for qualified personnel only)

4.2.6.4 MinLim Mass (for qualified personnel only)

4.2.6.5 MaxLim Mass (for qualified personnel only)

4.2.6.6 HYST Mass (for qualified personnel only)

4.2.6.7 Tank Characteristic (for qualified personnel only)

4.2.6.8 Calibrate/table or Calculate (for qualified personnel only)

Note: The value of Parameter 4.2.6.8 is determined by the selection (Calibrate/table or Calculate) in Parameter 4.2.6.7.

4.2.6.8 Calibrate/table

4.2.6.8.1 Calibrate (for qualified personnel only)

4.2.6.8.2 Enter table (for qualified personnel only)

4.2.6.8.3 Show table (for qualified personnel only)

4.2.6.8.4 Clear table (for qualified personnel only)

or

4.2.6.8 Calculate

4.2.6.8.1 Tank design (for qualified personnel only)

4.2.6.8.2 Bottom design (for qualified personnel only)

4.2.6.8.3 Tank volume (for qualified personnel only)

4.2.6.8.4 Tank height (for qualified personnel only)

4.2.6.9 Density (for qualified personnel only)

4.2.7.x User1 Parameters (for qualified personnel only)

All parameters in range 4.2.7.x are for Factory Authorized Personnel only. Advanced echo processing parameters should only be modified by qualified personnel.

4.2.8.x User2 Parameters (for qualified personnel only)

All parameters in range 4.2.8.x are for Factory Authorized Personnel only. Advanced echo processing parameters should only be modified by qualified personnel.

4.3: Analog Output

4.3.1 Error Level (F = D: Error Signal)

Level for the error signal to alarm in Analog or Digital output

Value	D: Error Signal
	D+F: Error Signal
	D+F+W: Error Signal

When D is selected, all errors are displayed. When D+F is selected, there is special handling for failsafe. When D+F+W is selected, there is special handling for warnings. For more information on Error Signal causes, see *Fault Messages* on page 82.

4.3.2 AO Select (F = Level)

Assignment of a measured value to the analog output

Value	Level
	Volume
	Mass

Here you can set whether the analog output supplies the level, volume, or mass to the control system.

Note: The value of Parameter 4.3.3 is determined by the selection (Level, Volume or Mass) in Parameter 4.3.2 (AO select).

If 4.3.2 (AO Select) = Level

4.3.3 Level Parameter (= Parameter 4.2.4)

If 4.3.2 (AO Select) = Volume

4.3.3 Volume Parameter (= Parameter 4.2.5)

If 4.3.2 (AO Select) = Mass

4.3.3 Mass Parameter (= Parameter 4.2.6)

4.3.4 Current Limit (F = 20 mA)

Upper current limit

Value	20 - 22.5 mA
--------------	--------------

Here you can set the upper current limit of the output signal in steps of 0.1 mA.

Current limiting

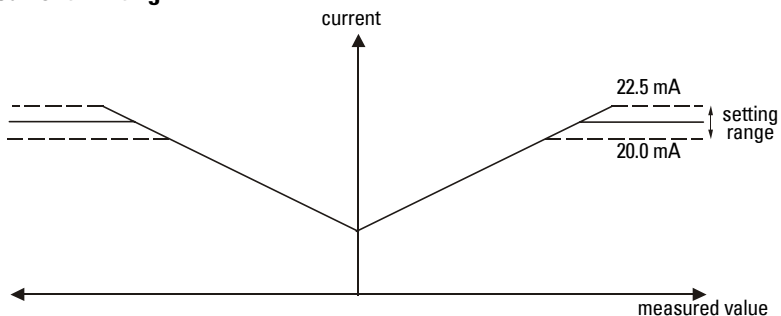

The URV is always at 20 mA. If you set the current limit to a higher value, you can have the measured values output outside the measuring range (up to approx. 115%).

4.3.5 Error Signal (F = 3.6 mA)

Current value of the error signal

Value	3.6 mA
	22.5 mA
	Hold 10 s
	Hold 1 min
	Hold 2 min
	Hold 3 min
	Hold continuously

In the event of a fault the device applies the current defined here to the analog output.

When the **Hold...** values are selected, the device outputs the last valid value until the appropriate time has run out or the fault has been eliminated. If the fault persists after the set time runs out, the analog output switches to an error signal of 3.6 mA.

Note: A fault is different from a loss of echo which indicates a failsafe condition. A fault indicates an error with internal electronics, hardware, or software.

4.4 Digital Output

4.4.1 Function DO (F = Alarm)

Assignment of the digital output

Value	MaxLim level
	MinLim level
	Alarm
	No function

Here you can select whether the digital output supplies the upper or lower limit value of level or an alarm (device error, measurement error; see Parameter 3.1) to the control system. If you select the **No function** option, the digital output is switched off.

Note: Selection of a limit value enables Parameter 4.4.4. If you select **Alarm** or **No function** in this parameter, Parameter 4.4.4 will not be visible.

4.4.2 Error Level (F = D: Error Signal)

Level for the error signal to alarm in Analog or Digital output

Value	D: Error signal
	D+F: Error signal
	D+F+W: Error signal

When D is selected, all errors are displayed. When D+F is selected, there is special handling for failsafe. When D+F+W is selected, there is special handling for warnings. For more information on Error Signal causes, see *Fault Messages* on page 82.

4.4.3 Signal Type DO (F = Relay closes)

Value	Relay closes
	Relay opens

Here you can determine the behavior of the digital output. Select whether the digital output contact closes or opens at an event.

If 4.4.1 (Function DO) = MaxLim level or MinLim level

4.4.4 Level Parameter (= Parameter 4.2.4)

4.5 Display Parameters

4.5.1 Multi Display

4.5.1.1 Line 1 Local (F = Level)

Choice of measured value in line 1

Value	Level
	Volume
	Mass

Note: The value of 4.5.1.3 is determined by the selection (Level, Volume or Mass) in Parameter 4.5.1.1 (Line 1 Local).

4.5.1.2 Display Local (F = Eng Unit)

Line 1 of local display

Value	Eng unit
	%
	Bar graph

If 4.5.1.1 (Line 1 Local) = Level**4.5.1.3 Level Parameter (= Parameter 4.2.4)****If 4.5.1.1 (Line 1 Local) = Volume****4.5.1.3 Volume Parameter (= Parameter 4.2.5)****If 4.5.1.1 (Line 1 Local) = Mass****4.5.1.3 Mass Parameter (= Parameter 4.2.6)****4.5.1.4 Line 2 Local (F = S/N ratio)***Line 2 of local display*

Value	Level
	Volume
	Mass
	Temperature
	Validity
	S/N ratio
	Amplitude
	Digital output
	Analog output

Note: Parameter 4.5.1.5 is displayed if Parameter 4.5.1.4 (Line 2 Local) = Level, Volume, or Mass.

If 4.5.1.4 (Line 2 Local) = Level**4.5.1.5 Level Parameter (= Parameter 4.2.4)****If 4.5.1.4 (Line 2 Local) = Volume****4.5.1.5 Volume Parameter (= Parameter 4.2.5)****If 4.5.1.4 (Line 2 Local) = Mass****4.5.1.5 Mass Parameter (= Parameter 4.2.6)****4.5.2 Language Local (= Parameter 1.1)****4.5.3 LCD Backlight (F = off)***Background illumination of the LCD*

Value	On
	Off

4.6: Device Information

4.6.1 Power Supply (according to customer specifications)

Voltage range of the built-in power supply unit

Value	non-editable
--------------	--------------

4.6.2 Flange Temperature (according to customer specifications)

Temperature range of the flange in °C

Value	non-editable
--------------	--------------

4.6.3 Electrical Connection (according to customer specifications)

Value	non-editable
--------------	--------------

4.6.4 Antenna and Flange

4.6.4.1 Flange Size (according to customer specifications)

Size of the flange

Value	DN 50, 2"
	DN 80, 3"
	DN 100, 4"
	DN 150, 6"
	Special design

4.6.4.2 Flange Type (according to customer specifications)

Type of flange

Value	DIN
	ANSI
	JIS
	Universal solid
	Universal liquid
	Easy Aimer
	Special design

4.6.4.3 Pressure Range (according to customer specifications)

Pressure range of the process connection

Value	non-editable
--------------	--------------

4.6.4.4 Antenna Type (according to customer settings)

Horn type

Value	Long, for liquids
	Short, for liquids
	Horn type 2" (51 mm) for solids (special request only)
	Horn type 3" (76 mm) for solids
	Horn type 4" (102 mm) for solids
	Special design

4.6.4.5 Antenna Extensions

Specifies antenna extension installed on device

Value	0 mm
	100 mm
	200 mm
	Special design

4.6.4.6 Flange Material (according to customer specifications)

Flange material

Value	316 Stainless steel
	304 Stainless steel
	Special design

4.6.4.7 Seal Material (according to customer specifications)

Sealing material

Value	PTFE ¹
	FFKM
	FKM
	Special design

1. PTFE: Polytetrafluoroethylene; FFKM: Perfluoroelastomer; FKM: Fluoroelastomer

4.6.5 Tag (according to customer specifications)

Device identification

Value	up to any eight characters
--------------	----------------------------

4.6.6 Descriptor (according to customer specifications)

Measuring point description

Value	up to any 16 characters
--------------	-------------------------

4.6.7 Message (according to customer specifications)

Measuring point message, e.g. the date of the last check or clean

Value	Up to any 32 characters
--------------	-------------------------

4.6.8 Manufacturer Identification

4.6.8.1 Serial Number (F = unique number)

Factory serial number

Value	non-editable
--------------	--------------

4.6.8.2 Delivery Order Number (according to customer specifications)

Device order number as shipped from the factory

Value	non-editable
--------------	--------------

4.6.8.3 Fld Device Revision (F = Number)

Device version

Value	non-editable
--------------	--------------

4.6.8.4 Firmware Revision (F = Number)

Value	non-editable
--------------	--------------

4.6.8.5 Hardware Revision (F = Number)

Value	non-editable
--------------	--------------

4.6.8.6 Antenna Offset (F = approx. 0.5 m [*calibration value])

Distance from sensor to flange

The antenna offset defines the propagation time of the measuring signal between the sensor and the flange as a distance. It is preset at the factory and cannot be changed.

4.6.8.7 Reference Difference (F = approx. 106 m [*calibration value])

Internal reference distance

The length of the reference distance in the units selected according to Parameter 4.1.5 is view-only. The device uses this value to calibrate itself so that no manual adjustment is necessary over long-term operation.

5. Options

5.1 Enter Code

Input of customer code to enable programmability

Value	Customer code
--------------	---------------

The device compares a code number which you enter here with the code defined in Parameter 5.2. If your entry matches the customer code completely, it releases the programming lock for all parameters for 10 minutes. Any other code number locks and disables programming.

5.2 Customer Code (F = 0)

Determination of customer code

Value	Up to 9-digit code
--------------	--------------------

Here you define the customer code (up to nine digits), with which you can protect the device parameters against programming errors. It is strongly recommended that a customer code be entered after all programming is completed to secure the programmed values from changes.

Use of the customer code is explained in *Disabling and Enabling Programming* on page 23.

5.3 Factory Reset (F = no)

Reset all parameters to factory setting

Value	Yes
	No

This parameter allows you to reset all parameters to the original factory setting as described in Parameters (HART) beginning on page 26.

6. Maintenance Settings

Use these parameters to set up schedules for calibration and maintenance. The device will track itself based on operating hours, instead of a calendar-based schedule, and will monitor its predicted lifetime.

The maintenance warnings and alarms are communicated to the end user through either the status or condensed status bytes. This information can be integrated into any Asset Management system. For optimal use, we recommend that you use SIMATIC PCS7 Asset Management Software in conjunction with SIMATIC PDM.

6.1 Remaining Device Lifetime

Note: Performing a reset to Factory Defaults will reset all Maintenance parameters to their factory defaults.

The Remaining Device/Sensor Lifetime parameters set up schedules for calibration and maintenance.

To access these parameters via SIMATIC PDM open the menu **Device – Maintenance** and select the **Remaining Device Lifetime** tab.

6.1.1 Total Device Operating Time

Read only. Displays the amount of time the device has been operating.

6.1.2 Remaining Device Lifetime

Read only. The sum of Total Expected Device Life less Total Device Operating Time.

6.1.3 Maintenance Required Limit¹

If the Total Expected Device Life less Total Device Operating Time is equal to or less than this limit, a Maintenance Required status is generated.

Values	Range: 0 to 20 years
	Default: 0.164 years

To modify the value via SIMATIC PDM:

- a. Modify limit values as required.
- b. See **6.1.5 Maintenance Alert Activation** to set Alert Activation options.

¹ Data for this parameter must be entered in seconds on the device.

6.1.4 Maintenance Demanded Limit¹

If the Total Expected Device Life less Total Device Operating Time is equal to or less than this limit, a Maintenance Demanded status is generated.

Values	Range: 0 to 20 years
	Default: 0.019 years

To modify the value via SIMATIC PDM:

- Modify limit values as required.
- See **6.1.5 Maintenance Alert Activation** to set Alert Activation options.

6.1.5 Maintenance Alert Activation

Select limits to be activated.

Values	ON, LIMIT 1	Enable Maintenance Required Alert
	ON, LIMIT 2	Enable Maintenance Demanded Alert
	ON, LIMITS 1 + 2	Enable both Maintenance Required and Demanded Alerts
	* OFF	Off

To enable or disable Maintenance Alert Activation via SIMATIC PDM:

- First set the limit values in **6.1.3 Maintenance Required Limit/6.1.4 Maintenance Demanded Limit1**.
- Select the desired Alert Activation option.

6.1.6 Total Expected Device Life¹

The device tries to predict its overall lifetime. The factory default can be reset by the user.

Values	Range: 0 to 20 years
	Default: 10.00 years

To modify the value via SIMATIC PDM:

- Open the menu **Device – Maintenance** and click on **Remaining Device Lifetime**.
- Enter the desired value (or click **Snooze** to add a year to the current value), then click on **Write** to accept the change.
- Click on **Read** to view the effect of the modification.

¹ Data for this parameter must be entered in seconds on the device.

6.1.7 Units

Allows you to set desired units using SIMATIC PDM.

Options	SECONDS
	HOURS
	DAYS
	YEARS

6.1.8 Maintenance Status

Read only. Displays the status of the Maintenance Alerts.

Options (read only)	OK	None
	MAINT REQ	Maintenance Required
	MAINT DEM	Maintenance Demanded

To view via SIMATIC PDM open the menu **View - Device Status** (PROFIBUS PA) or **View – Status** (HART), click on the **Maintenance** tab, and check the **Device Lifetime Status** window.

6.1.9 Acknowledge Status

Read only. Displays the status of the Maintenance Alerts that have been acknowledged.

Options (read only)	ACK NOTHING	None
	ACK MAINT REQ	Maintenance Required Acknowledged
	ACK MAINT DEM	Maintenance Demanded Acknowledged

To view via SIMATIC PDM open the menu **View - Device Status** (PROFIBUS PA) or **View – Status** (HART), click on the **Maintenance** tab, and check the **Device Lifetime Status** window.

6.1.A Acknowledge

Allows you to acknowledge either a Maintenance Required or a Maintenance Demanded alert.

To acknowledge an alert via SIMATIC PDM:

- Open the menu **View - Device Status** (PROFIBUS PA) or **View – Status** (HART), and click on the **Maintenance** tab.
- In the **Device Lifetime** window click on **Acknowledge Warnings**.

Options (read only)	DO NOTHING
	ACKNOWLEDGE

6.2 Remaining Sensor Lifetime

The device monitors the predicted lifetime of the sensor (the components exposed to the vessel environment).

To access these values via SIMATIC PDM, open the menu **Device - Maintenance** and select the **Remaining Sensor Lifetime** tab.

6.2.1 Total Sensor Operating Time

Read only. Displays the amount of time the sensor has been operating.

Can be set to zero via the handheld programmer (after performing a service).

6.2.2 Remaining Sensor Lifetime

Read only. The sum of Total Expected Sensor Life less Total Sensor Operating Time.

6.2.3 Maintenance Required Limit¹

If the Total Expected Sensor Life less Total Sensor Operating Time is equal to or less than this limit, a Maintenance Required status is generated.

Values	Range: 0 to 20 years
	Default: 0.164 years

To modify the value via SIMATIC PDM:

- a. Modify limit values as required.
- b. Enable **6.2.5 Maintenance Alert Activation** to set the Alert Activation options.

6.2.4 Maintenance Demanded Limit¹

If the Total Expected Sensor Life less Total Sensor Operating Time is equal to or less than this limit, a Maintenance Demanded status is generated.

Values	Range: 0 to 20 years
	Default: 0.019 years

To modify the value via SIMATIC PDM:

- a. Modify limit values as required.
- b. Enable **6.2.5 Maintenance Alert Activation** to set the Alert Activation options.

¹. Data for this parameter must be entered in seconds on the device.

6.2.5 Maintenance Alert Activation

Select limits to be activated.

Values	ON, LIMIT 1	Enable Maintenance Required Alert
	ON, LIMIT 2	Enable Maintenance Demanded Alert
	ON, LIMITS 1 + 2	Enable both Maintenance Required and Demanded Alerts
	* OFF	Off

To enable or disable Maintenance Alert Activation via SIMATIC PDM:

- First set the limit values in **6.2.3 Maintenance Required Limit/6.2.4 Maintenance Demanded Limit**.
- Select the desired Alert Activation option.
- Click on **Write** to accept the change.

6.2.6 Total Expected Sensor Life¹

The device tries to predict its overall lifetime. You can reset the factory default.

Values	Range: 0 to 20 years
	Default: 10.00 years

To modify the value via SIMATIC PDM:

- Open the menu **Device – Maintenance** and click on **Remaining Sensor Lifetime**.
- Enter the desired value (or click on **Snooze** to add a year to the current value) then click on **Write** to accept the change.
- Click on **Read** to view the effect of the modification.

6.2.7 Units

Allows you to set desired units using SIMATIC PDM.

Options	SECONDS
	HOURS
	DAYS
	YEARS

¹ Data for this parameter must be entered in seconds on the device.

6.2.8 Maintenance Status

Read only. Displays the status of the Maintenance Alerts.

Options (read only)	OK	None
	MAINT REQ	Maintenance Required
	MAINT DEM	Maintenance Demanded

To view via SIMATIC PDM open the menu **View - Device Status** (PROFIBUS PA) or **View – Status** (HART), click on the **Maintenance** tab, and check the **Sensor Lifetime Status** window.

6.2.9 Acknowledge Status

Read only. Displays the status of the Maintenance Alerts that have been acknowledged.

Options (read only)	ACK NOTHING	None
	ACK MAINT REQ	Maintenance Required Acknowledged
	ACK MAINT DEM	Maintenance Demanded Acknowledged

To view via SIMATIC PDM open the menu **View - Device Status** (PROFIBUS PA) or **View – Status** (HART), and click on the **Maintenance** tab and check the **Sensor Lifetime Status** window.

6.2.A Acknowledge

Allows you to acknowledge either a Maintenance Required or a Maintenance Demanded alert.

To acknowledge an alert via SIMATIC PDM:

- Open the menu **View - Device Status** (PROFIBUS PA) or **View – Status** (HART), and click on the **Maintenance** tab.
- In the **Sensor Lifetime** window click on **Acknowledge Warnings**.

Options (read only)	DO NOTHING
	ACKNOWLEDGE

6.3 Service Interval

Allows for scheduling of service inspections.

To access these parameters via SIMATIC PDM, open the menu **Device – Maintenance** and click on the **Service Interval** tab.

6.3.1 Time Elapsed since Last Service

Read only. Time elapsed since device was last serviced.

Can be reset to zero via the handheld programmer (after performing a service).

6.3.2 Maintenance Required Limit¹

If the Total Service Interval less the Time Lapsed from Last Service is equal to or less than this limit, a Maintenance Required status is generated.

Values	Range: 0 to 20 years
	Default: 0.164 years

6.3.3 Maintenance Demanded Limit¹

If the Total Service Interval less the Time Lapsed from Last Service is equal to or less than this limit, a Maintenance Demanded status is generated.

Values	Range: 0 to 20 years
	Default: 0.019 years

6.3.4 Maintenance Alert Activation

Select limits to be activated.

Options	*	OFF	Timer Off
		ON - NO LIMITS	Timer On, No Limit Checking
		ON, LIMIT 1	Timer On, Maintenance Required Enabled
		ON, LIMITS 1 + 2	Timer On, Maintenance Required and Demanded Enabled
		ON, LIMIT 2	Timer On, Maintenance Demanded Enabled

6.3.5 Total Service Interval¹

Set time between scheduled service inspections.

Values	Range: 0 to 20 years
	Default: 1.0 year

¹. Data for this parameter must be entered in seconds on the device.

6.3.6 Units

Allows you to set desired units using SIMATIC PDM.

Options	SECONDS
	HOURS
	DAYS
	YEARS

6.3.7 Maintenance Status

Read only. Displays the status of the Maintenance Alerts.

Options (read only)	OK	None
	MAINT REQ	Maintenance Required
	MAINT DEM	Maintenance Demanded

In SIMATIC PDM, open the menu **View - Device Status** (PROFIBUS PA) or **View – Status** (HART), click on the **Maintenance** tab and check the **Service Interval** window.

6.3.8 Acknowledge Status

Read only. Displays the status of the Maintenance Alerts that have been acknowledged.

Options (read only)	ACK NOTHING	None
	ACK MAINT REQ	Maintenance Required Acknowledged
	ACK MAINT DEM	Maintenance Demanded Acknowledged

In SIMATIC PDM, open the menu **View - Device Status** (PROFIBUS PA) or **View – Status** (HART), click on the **Maintenance** tab and check the **Service Interval** window.

6.3.9 Acknowledge

Allows you to acknowledge either a Maintenance Required or a Maintenance Demanded alert.

In SIMATIC PDM:

- Open the menu **View - Device Status** (PROFIBUS PA) or **View – Status** (HART), and click on the **Maintenance** tab.
- In the **Service Interval** window, click on **Acknowledge Warnings**.

Options (read only)	DO NOTHING
	ACKNOWLEDGE

6.4 Calibration Interval

Allows you to schedule calibration.

To access these parameters via SIMATIC PDM, open the menu **Device – Maintenance** and click on the **Calibration Interval** tab.

6.4.1 Time Elapsed Since Last Calibration

Read only: time elapsed since device was last calibrated.

Can be reset to zero via the handheld programmer (after performing a service).

6.4.2 Maintenance Required Limit¹

If the Total Calibration Interval less the Time Lapsed from Last Calibration is equal to or less than this limit, a Maintenance Required status is generated.

Values	Range: 0 to 20 years
	Default: 0.164 years

6.4.3 Maintenance Demanded Limit¹

If the Total Calibration Interval less the Time Lapsed from Last Calibration is equal to or less than this limit, a Maintenance Demanded status is generated.

Values	Range: 0 to 20 years
	Default: 0.019 years

6.4.4 Maintenance Alert Activation

Select limits to be activated.

Options	*	OFF	Timer Off
		ON - NO LIMITS	Timer On, No Limit Checking
		ON, LIMIT 1	Timer On, Maintenance Required Enabled
		ON, LIMITS 1 + 2	Timer On, Maintenance Required and Demanded Enabled
		ON, LIMIT 2	Timer On, Maintenance Demanded Enabled

¹. Data for this parameter must be entered in seconds on the device.

6.4.5 Total Calibration Interval¹

Set time between scheduled calibrations.

Values	Range: 0 to 20 years
	Default: 1.0 year

6.4.6 Units

Allows you to set desired units using SIMATIC PDM.

Options	SECONDS
	HOURS
	DAYS
	YEARS

6.4.7 Maintenance Status

Read only: Displays the status of the Maintenance Alerts.

Options (read only)	OK	None
	MAINT REQ	Maintenance Required
	MAINT DEM	Maintenance Demanded

In SIMATIC PDM, open the menu **View - Device Status** (PROFIBUS PA) or **View - Status** (HART), click on the **Maintenance** tab and check the **Calibration Interval** window.

6.4.8 Acknowledge Status

Read only: displays the status of the Maintenance Alerts that have been acknowledged.

Options (read only)	ACK NOTHING	None
	ACK MAINT REQ	Maintenance Required Acknowledged
	ACK MAINT DEM	Maintenance Demanded Acknowledged

In SIMATIC PDM, open the menu **View - Device Status** (PROFIBUS PA) or **View - Status** (HART), click on the **Maintenance** tab and check the **Calibration Interval** window.

6.4.9 Acknowledge

Allows you to acknowledge either a Maintenance Required or a Maintenance Demanded alert.

In SIMATIC PDM:

- a. Open the menu **View - Device Status** (PROFIBUS PA) or **View – Status** (HART), and click on the **Maintenance** tab.
- b. In the **Calibration Interval** window, click on **Acknowledge Warnings**.

Options (read only)	DO NOTHING
	ACKNOWLEDGE

Parameters (PROFIBUS PA)

Parameters (PROFIBUS PA)

Note: For parameter descriptions, please refer to the associated HART parameters on pages 26 to 67.

Parameter, menu identification	Description	Factory Setting	Setting Possibilities
1: Auto-Setup			
1.1 Language local	Selects the language to be used on the LCD	English	English Deustch
1.2 Length unit	Specifies measurement units used for dimension values	m	cm m mm ft in
1.3 Nozzle height	Specifies length of nozzle from top of device flange to top of vessel	0 m	numerical value
1.4 Tank height	Specifies height of vessel from nozzle bottom to vessel bottom	20 m	numerical value
1.5 Level URV	Sets the full scale of level	20 m	numerical value
1.6 Level LRV	Sets the distance from the bottom of the vessel to the empty level	0 m	numerical value
1.7 Level damping	Sets the damping of the level value in seconds	1 s	numerical value
1.8 Application type	Sets the use of the vessel	Liquid (process)	Liquid (store) Liquid (process) Silo1 (solids) Silo2 (solids) User tank1 User tank2
1.9 Bus address	Current bus address	126	0 to 126
2: Display			
2.1: Multi-display	Display of two measured values	Level/Signal-to-noise ratio in dB	Read-only
2.2: Level	Level of material	m	Read-only
2.3: Volume	Volume of material	m ³	Read-only
2.4: Mass	For qualified personnel only		
3: Diagnostics			
3.1: Status			
3.1.1: Wear			

Parameters (PROFIBUS PA)

Note: For parameter descriptions, please refer to the associated HART parameters on pages 26 to 67.

Parameter, menu identification	Description	Factory Setting	Setting Possibilities
3.1.1.1: Operating hours	Total previous operating time of the device in hours (approximate value)		Read-only
3.1.1.2: Maximum temp.	Last recorded maximum internal temperature of device		Read-only
3.1.1.3: Minimum temp.	Last recorded minimum internal temperature of the device		Read-only
3.1.1.4: Aging	Approximate value for the prior life of the device in % (100% = approx. 10 years)		Read-only
3.1.1.5: Hours > 85°C	Total time the maximum permissible internal temperature (85 °C) was exceeded, in hours		Read-only
3.1.x: Sensor and/or	Diagnostic messages of the sensor		Read-only
3.1.x: Electronics and/or	Diagnostic messages of the electronics		Read-only
3.1.x: Software and/or	Diagnostic messages of the software		Read-only
3.1.x: Application and/or	Diagnostic messages to the application		Read-only
3.1.x: Parameters and/or	Display of the false parameters		Read-only
3.1.x: Service MC and/or	For qualified personnel only		Read-only
3.1.x: Service DSP			
3.2: Device test			
3.2.1: Self-test	Check device state		Read-only
3.2.2: Display test	Visual check of LCD		Read-only
3.3: Simulation			
3.3.1: Error Simulation for Micro High Word	For factory service purposes only		

Parameters (PROFIBUS PA)

Note: For parameter descriptions, please refer to the associated HART parameters on pages 26 to 67.

Parameter, menu identification	Description	Factory Setting	Setting Possibilities
3.3.2: Error Simulation for Micro Low Word	For factory service purposes only		
3.3.3: Error Simulation for DSP High Word	For factory service purposes only		
3.3.4: Error Simulation for DSP Low Word	For factory service purposes only		
3.4: Sensor variables			
3.4.1: Raw value	Distance from flange to material		
3.4.2: Echo amplitude	Measure of quality of reflection		
3.4.3: S/N ratio	Signal-to-noise ratio of the measured value in dB		
3.4.4: Validity	Validity of the measured value in %		
3.4.5: Sensor temp	Internal electronics sensor temperature		
4: Device data			
4.1: Units			
4.1.1 Length unit	= [1.2]		
4.1.2: Volume unit	Specifies volume units used for dimensional values	m ³	bbl yd ³ ft ³ in ³ bush bbl (liq) l m ³ hL Gal ImpGal
4.1.3: Mass unit	Specifies mass units used for dimensional values	kg	kg Ton lb LTon STon

Parameters (PROFIBUS PA)

Note: For parameter descriptions, please refer to the associated HART parameters on pages 26 to 67.

Parameter, menu identification	Description	Factory Setting	Setting Possibilities
4.1.4: Temperature unit	Unit of the internal electronics sensor temperature	°C	°C °F K
4.1.5: Other units	Units system for all other units	SI	SI unit US/UK unit
4.2: Operating parameters			
4.2.1: Tank geometry			
4.2.1.1: Nozzle height	= [1.3]		
4.2.1.2: Tank height	= [1.4]		
4.2.1.3: Stilling pipe? [7ML5421 version]	Stilling pipe available?	no	yes no
If yes, 4.2.1.3.2: Pipe diameter [7ML5421 version]	Diameter (internal) of the stilling pipe	100 mm	numerical value
4.2.2: Measuring conditions			
4.2.2.1: Applic. type	Use of the vessel	Liquid (process)	Liquid (store) Liquid (process) Silo1 (solids) Silo2 (solids) User tank1 User tank2
4.2.2.2: Surface	Surface structure of the material Not displayed if a user tank is selected in [4.2.2.1].	wavy	smooth wavy turbulent
4.2.2.3: Dead band	Defines the distance from below the flange to be ignored by the transmitter/receiver	0.35 m	numerical value, Minimum value = Length of the antenna
4.2.2.4: Correction factor	Correction factor for physical measuring influences. Generally only applies to liquid applications using a stilling well.	1.0	numerical value
4.2.2.5: Filling speed	Typical speed of change of the level Not displayed if a user tank is selected in [4.2.2.1].	200 mm/min	numerical value

Parameters (PROFIBUS PA)

Note: For parameter descriptions, please refer to the associated HART parameters on pages 26 to 67.

Parameter, menu identification	Description	Factory Setting	Setting Possibilities
4.2.2.6 Reflectivity	For qualified personnel only		
4.2.2.7: Failsafe level	Selects the default measurement in the event the failsafe timer expires	Hold	100 % 0 % Hold
4.2.2.8: Failsafe timer	Sets the time delay, in minutes, before going into failsafe level	10 min	1 min 2 min etc.
4.2.2.9: Range extension	Sets the range extension as measured from the vessel height and extending beyond the measurement range.	3 m	1 m 2 m etc.
4.2.3: Sensor parameter			
4.2.3.1: Sensor damping	Averaging of measuring signal (Not displayed if a user tank is selected in [4.2.2.1].)	1 s	numerical value
4.2.3.2: Multiple echo	Evaluate multiple echoes	on	on off
4.2.3.3: Echo motion	Evaluate echo motion	on	on off
4.2.3.4: Window tracking	Evaluate moving targets	off	on off
4.2.3.5: Tank empty detect	For qualified personnel only		
4.2.3.6: Auto fix distance	For qualified personnel only		
4.2.3.7: Fix Dist List	For qualified personnel only		
4.2.3.7.1 to 4.2.3.7.9: Fix Dist List values	For qualified personnel only		
4.2.3.8: Auto False Echo suppression	Learns and records the current signal up to the suppression distance setting. These signals are then ignored during operation.	use	use record off
4.2.3.9: Auto False Echo suppression distance	Defines the end point of the Auto False-Echo Suppression distance	2/3 tank height	variable

Parameters (PROFIBUS PA)

Note: For parameter descriptions, please refer to the associated HART parameters on pages 26 to 67.

Parameter, menu identification	Description	Factory Setting	Setting Possibilities
4.2.3.A Hover level	Defines (in %) how high the TVT curve is placed above echo profile, relative to the largest echo	40%	0 to 100%
4.2.3.B Window Trigger	Defines position of window on leading edge of selected echo, relative to amplitude	80%	0 to 100%
4.2.4: Level param.			
4.2.4.1: Level URV	= [1.5]		
4.2.4.2: Level LRV	= [1.6]		
4.2.4.3: Level damping	= [1.7]		
4.2.4.4: MinWarn level	Limit before reaching lower limit value	0 m	numerical value
4.2.4.5: MinLim level	Lower limit value of the level (See Functional Dimensions Diagram)	0 m	numerical value
4.2.4.6: MaxLim level	Upper limit value of the level (See Functional Dimensions Diagram)	20 m	numerical value
4.2.4.7: MaxWarn level	Limit before reaching upper limit value	20 m	numerical value
4.2.4.8: HYST level	Hysteresis of the level limit values	0.5 m	numerical value
4.2.5: Volume param.			
4.2.5.1: Volume URV	Full scale of the volume	20 m ³	numerical value
4.2.5.2: Volume LRV	Start of scale of the volume	0 m ³	numerical value
4.2.5.3: Volume damping	Damping of the volume	1 s	numerical value
4.2.5.4: MinWarn volume	Limit before reaching lower limit value	0 m ³	numerical value
4.2.5.5: MinLim volume	Lower limit value of the volume	0 m ³	numerical value
4.2.5.6: MaxLim volume	Upper limit value of the volume	20 m ³	numerical value
4.2.5.7: MaxWarn volume	Limit before reaching upper limit value	20 m	numerical value

Parameters (PROFIBUS PA)

Note: For parameter descriptions, please refer to the associated HART parameters on pages 26 to 67.

Parameter, menu identification	Description	Factory Setting	Setting Possibilities
4.2.5.8: HYST volume	Hysteresis of the volume limit values	0.5 m ³	numerical value
4.2.5.9: Tank characteristic	Determining the tank characteristic	Calculate	Calibrate/table Calculate
4.2.5.A: Calibrate/table or 4.2.5.A: Calculate			
4.2.5.A.1: Calibrate or 4.2.5.A.1: Tank design	Automatic litering		Confirm input
		Vertical cylinder	Linear Vertical cylinder Horizontal Cylinder Sphere
4.2.5.A.2: Enter table or 4.2.5.A.2: Bottom design	Manual entry of a table		numerical value
		Dished end	Dished end Basket end Bullet bottom
4.2.5.A.3: Show table or 4.2.5.A.3: Tank volume	Display table		Selection
		20 m ³	numerical value
4.2.5.A.4: Clear table or 4.2.5.A.4: Tank height	Delete table = [4.2.1.2]		Selection
4.2.6: Mass Parameters	For qualified personnel only		
4.2.6.1: Mass URV	For qualified personnel only		
4.2.6.2: Mass LRV	For qualified personnel only		
4.2.6.3: Mass damping	For qualified personnel only		
4.2.6.4: MinWarn Mass	For qualified personnel only		
4.2.6.5: MinLim mass	For qualified personnel only		
4.2.6.6: MaxLim mass	For qualified personnel only		
4.2.6.7: MaxWarn Mass	For qualified personnel only		
4.2.6.8: HYST Mass	For qualified personnel only		
4.2.6.9: Tank Character	For qualified personnel only		

Parameters (PROFIBUS PA)

Note: For parameter descriptions, please refer to the associated HART parameters on pages 26 to 67.

Parameter, menu identification	Description	Factory Setting	Setting Possibilities
4.2.6.A: Calibrate/table or 4.2.6.A: Calculate			
4.2.6.A.1: Calibrate or 4.2.6.A.1: Tank design	For qualified personnel only		
	For qualified personnel only		
4.2.6.A.2: Enter table or 4.2.6.A.2: Bottom design	For qualified personnel only		
	For qualified personnel only		
4.2.6.A.3: Show table or 4.2.6.A.3: Tank volume	For qualified personnel only		
	For qualified personnel only		
4.2.6.A.4: Clear table or 4.2.6.A.4: Tank height	For qualified personnel only		
	For qualified personnel only		
4.2.6.B: Density	For qualified personnel only		
4.2.7.x: User Parameters 1	For qualified personnel only		
4.2.8.x: User Parameters 2	For qualified personnel only		
4.3: Output parameter			
4.3.1: BusIdentNr.			Profile specific Manufacturer specific
4.3.2: Bus address	= [1.8}		
4.4: Display param.			
4.4.1: Multi display			
4.4.1.1: Line 1 local	Choice of measured value in line 1	Level	Level Volume Mass
4.4.1.2: Display local	Method of display in line 1	Eng unit	Eng unit % Bargraph

Parameters (PROFIBUS PA)

Note: For parameter descriptions, please refer to the associated HART parameters on pages 26 to 67.

Parameter, menu identification	Description	Factory Setting	Setting Possibilities
4.4.1.3: Level param. or 4.4.1.3: Volume param. or 4.4.1.3: Mass param.	= [4.2.4]		
	= [4.2.5]		
	= [4.2.6]		
4.4.1.4: Line 2 local	Display in line 2	S/N ratio	Level Volume Mass Temperature Validity S/N ratio Amplitude Digital output Analog output
4.4.1.5: Level param. or 4.4.1.5: Volume param. or 4.4.1.5: Mass param.	= [4.2.4]		
	= [4.2.5]		
	= [4.2.6]		
4.4.2: Language local	= [1.1]		
4.4.3: LCD backlight	Background illumination of the LCD	off	on off
4.5: Device info			
4.5.1: Power supply	Voltage range of the built-in power supply unit	according to customer specifications	Read-only
4.5.2: Flange temp.	Temperature range of the flange in °C	according to customer specifications	Read-only
4.5.3: Electrical connection		according to customer specifications	Read-only
4.5.4: Antenna and flange			

Parameters (PROFIBUS PA)

Note: For parameter descriptions, please refer to the associated HART parameters on pages 26 to 67.

Parameter, menu identification	Description	Factory Setting	Setting Possibilities
4.5.4.1: Flange size	Rated size of the flange	according to customer specifications	DN 50, 2" DN 80, 3" DN 100, 4" DN 150, 6" Special design
4.5.4.2: Flange type	Type of flange	according to customer specifications	DIN ANSI JIS Universal solid Universal liquid Easy Aimer Special design
4.5.4.3: Pressure range	Pressure range of the process connection	according to customer specifications	Read-only
4.5.4.4: Antenna type		according to customer specifications	long, liquids short, liquids 2", solid (special request only) 3", solid 4", solid
4.5.4.5: Antenna extension	Antenna extension(s) on device	0 mm	0 mm 100 mm 200 mm Special design
4.5.4.6: Flange material		according to customer specifications	316 SS 304 Special design
4.5.4.7: Seal material	Sealing material	according to customer specifications	PTFE FFKM FKM Special design
4.5.5: Tag	Device identification	according to customer specifications	up to any eight characters
4.5.6: Descriptor	Measuring point description	according to customer specifications	up to any 16 characters

Parameters (PROFIBUS PA)

Note: For parameter descriptions, please refer to the associated HART parameters on pages 26 to 67.

Parameter, menu identification	Description	Factory Setting	Setting Possibilities
4.5.7: Message	Measuring point message, e.g. the date of last check or clean	according to customer specifications	up to any 32 characters
4.5.8: Manufacturer identification			
4.5.8.1: Serial no.	Factory serial number	unique number	Read-only
4.5.8.2: Delivery order no.	Device order number as shipped from the factory	according to customer specifications	Read-only
4.5.8.3: Device revision	Device version	number	Read-only
4.5.8.4: Firmware revision		number	Read-only
4.5.8.5: Hardware revision		number	Read-only
4.5.8.6: Antenna offset	Distance sensor/flange	approx. 0.5 m (calibration value)	Read-only
4.5.8.7: Reference distance	Internal reference distance	approx. 106 m (calibration value)	Read-only
5: Options			
5.1: Enter code	Input of customer code to enable programmability		Customer code
5.2: Customer code	Determination of customer code	0	up to 9 digit code
5.3: Factory reset	Reset all parameters to factory setting	no	yes no
6: Maintenance Settings			
6.1: Remaining Device Lifetime			
6.1.1: Total Device Operating Time	For qualified personnel only		Read-only
6.1.2: Restlife	For qualified personnel only		Read-only
6.1.3: Maintenance Required Limit ¹	For qualified personnel only		Read/Write
6.1.4: Maintenance Demanded Limit ¹	For qualified personnel only		Read/Write

Parameters (PROFIBUS PA)

Note: For parameter descriptions, please refer to the associated HART parameters on pages 26 to 67.

Parameter, menu identification	Description	Factory Setting	Setting Possibilities
61.5: Maintenance Alert Activation	For qualified personnel only		Read/Write
61.6: Total Expected Device Life ¹	For qualified personnel only		Read/Write
61.7: Units	For qualified personnel only		Read/Write
61.8: Maintenance Status	For qualified personnel only		Read-only
61.9: Acknowledge Status	For qualified personnel only		Read-only
61.A Acknowledge	For qualified personnel only		Read/Write
6.2: Remaining Sensor Lifetime			
6.2.1: Total Sensor Operating Time	For qualified personnel only		Read-only
6.2.2: Restlife	For qualified personnel only		Read-only
6.2.3: Maintenance Required Limit ¹	For qualified personnel only		Read/Write
6.2.4: Maintenance Demanded Limit ¹	For qualified personnel only		Read/Write
6.2.5: Maintenance Alert Activation	For qualified personnel only		Read/Write
6.2.6: Total Expected Sensor Life ¹	For qualified personnel only		Read/Write
6.2.7: Units	For qualified personnel only		Read/Write
6.2.8: Maintenance Status	For qualified personnel only		Read-only
6.2.9: Acknowledge Status	For qualified personnel only		Read-only
6.2.A: Acknowledge	For qualified personnel only		Read/Write
6.3: Remaining Service Interval			
6.3.1: Time Elapsed Since Last Service	For qualified personnel only		Read-only
6.3.2: Maintenance Required Limit ¹	For qualified personnel only		Read/Write
6.3.3: Maintenance Demanded Limit ¹	For qualified personnel only		Read/Write

Parameters (PROFIBUS PA)

Note: For parameter descriptions, please refer to the associated HART parameters on pages 26 to 67.

Parameter, menu identification	Description	Factory Setting	Setting Possibilities
6.3.4: Maintenance Alert Activation	For qualified personnel only		Read/Write
6.3.5: Total Service Interval ¹	For qualified personnel only		Read/Write
6.3.6: Units	For qualified personnel only		Read/Write
6.3.7: Maintenance Status	For qualified personnel only		Read-only
6.3.8: Acknowledge Status	For qualified personnel only		Read-only
6.3.9: Acknowledge	For qualified personnel only		Read/Write
6.4: Calibration Interval			
6.4.1: Time Elapsed Since Last Calibration	For qualified personnel only		Read-only
6.4.2: Maintenance Required Limit ¹	For qualified personnel only		Read/Write
6.4.3: Maintenance Demanded Limit ¹	For qualified personnel only		Read/Write
6.4.4: Maintenance Alert Activation	For qualified personnel only		Read/Write
6.4.5: Total Calibration Interval ¹	For qualified personnel only		Read/Write
6.4.6: Units	For qualified personnel only		Read/Write
6.4.7: Maintenance Status	For qualified personnel only		Read/Write
6.4.8: Acknowledge Status	For qualified personnel only		Read-only
6.4.9: Acknowledge	For qualified personnel only		Read-only

¹. Data for these parameters must be entered in seconds on the device.

Troubleshooting

SITRANS LR400 is factory tested and calibrated. Carefully selected components and compliance with prescribed quality standards guarantee the high reliability of SITRANS LR400. Please review the instructions below for troubleshooting assistance before contacting Siemens Milltronics.

Classification of Faults

Faults occurring in SITRANS LR400 can be classified in the following groups:

- faults caused by ambient influences: over- and under-temperature, moisture, contamination by the material and other substances, mains faults, vibration
- faults in the device: display, electronics, mechanics, connections

Please try to determine the fault and localize it as accurately as possible.

Self-test

Note: When power is supplied, the device performs a self-test. Then, when the multi-display appears, the device is ready for programming.

If you get fault messages after the self-test, please proceed according to Fault Messages on page 82.

If there is a malfunction in the device, you can also activate the self-test manually with Parameter 3.2.1.

Symptoms, Causes and Their Remedy

Symptom	Possible causes	Remedy
No display on the LCD	Defective or missing power supply	Check that the power supply is connected correctly.
	LCD is defective	Connect a HART Communicator or a PC/Laptop with SIMATIC PDM software. If the device can be programmed from there, the LCD is defective.
	Electronics are defective	Measure the analog current output. If the output current is not between $3.6 \text{ mA} < x < 22 \text{ mA}$, the electronics are defective. Contact your local Siemens Milltronics representative.
A fault message is displayed	Internal fault	Call the fault display in Function 3.1. Proceed as described in Fault Messages starting on page 82
An incorrect measured value appears after Auto-Setup.	The device is not programmed correctly for the application	Set the device parameters and functions manually.

Symptom	Possible causes	Remedy
No measured value appears after the Auto-Setup (measured value 0 and the fault display flashes)	Internal fault	Call the fault display in Parameter 3.1. Proceed as described in Antenna Maintenance on page 86.
SITRANS LR400 reads 100% continually.	Check antenna for material buildup.	Clean antenna or order an optional PTFE dust cover.
	Nozzle interference, or end of horn is not inside vessel	Shorten nozzle or lower position of SITRANS LR400.
SITRANS LR400 reading stays above actual level	False echo from vessel (fixed obstruction)	Use 4.2.3.8 and 4.2.3.9 Auto False-Echo Suppression function
SITRANS LR400 reads low or empty when material level is high	Multiple or indirect echo detected instead of first echo.	Set 4.2.3.2 Multiple Echo Tracking to ON. Try using Liquid Store application type 4.2.2.1.
	Highly sloped surface	Aim SITRANS LR400 using Easy Aimer ball.
SITRANS LR400 reading is too slow.	Damping too high	Decrease 4.2.3.1 Sensor Damping
	Window Tracking was too slow.	Decrease Level Damping Set 4.2.3.4 to OFF (Window Tracking)

Fault Messages

The device indicates faults with a flashing letter on the right of the first line of the display. It has the following meaning:

- W: Warning – device is still ready for operation but faults may occur
- F: Fault – sporadic fault, device conditionally ready for operation
- D: Continuous fault – device is not ready for operation
- M: Maintenance fault – maintenance required or demanded. See maintenance parameters (Parameters 6.x).

Under Parameter 3.1.x, you will find a fault log which indicates the type of the fault(s) that occurred. It indicates the device function status in which the fault occurred and outputs a fault message in plain text. The possible fault messages are described below.

Possible fault messages:

Message	Possible causes	Remedy
Sensor		
MW cable defect	Faulty or damaged microwave cable	Repair required: contact your local Siemens representative.
Sensor defect	Faulty or damaged high frequency antenna	Repair required: contact your local Siemens representative.
Check antenna	Dirty high frequency antenna	Inspect antenna for contamination; clean if possible.
Sensor too hot	Sensor temperature above 85 °C(185 °F)	Reduce ambient temperature surrounding the device enclosure or reduce process temperature. Inspect sensor for damage and if necessary, contact your local Siemens representative.

Message	Possible causes	Remedy
Electronics		
Memory defect	Memory error	Reset power. If defect persists, perform a factory reset. If still defective, contact your local Siemens representative.
SSC/ASC defect	EEPROM failure	Repair required: contact your local Siemens representative.
ADC defect	ADC failure	Repair required: contact your local Siemens representative.
Communication processor defect	Either: 1. PROFIBUS card not found. 2. HART card not found.	Repair required: contact your local Siemens representative.
DSP defect	DSP failure	Repair required: contact your local Siemens representative.
Inaccurate measurement value	DSP failure	Repair required: contact your local Siemens representative.
Software		
Software error	Software watchdog time-out	Repair required: contact your local Siemens representative.
Self-calibration error	One or more of: 1. Temperature calibration value out of range. 2. Analog output calibration values not calibrated. 3. 'ReferenceLength' or 'AntennaOffset' not calibrated	Repair required: contact your local Siemens representative.
Application		
Invalid parameter setting	Parameters are inconsistent (for example, URV=LRV).	Adjust customer parameters.
Maintenance		
Device Lifetime Limit1	'Maint Required Limit' (Device Lifetime Limit 1) has exceeded the remaining device lifetime.	Replacement is recommended.
Device Lifetime Limit2	'Maint Demanded Limit' (Device Lifetime Limit 2) has exceeded the remaining device lifetime.	Replacement is recommended.
Sensor Lifetime Limit1	'Maint Required Limit' (Sensor Lifetime Limit 1) has exceeded the remaining sensor lifetime.	Replacement is recommended.
Sensor Lifetime Limit2	'Maint Demanded Limit' (Sensor Lifetime Limit 2) has exceeded the remaining sensor lifetime.	Replacement is recommended.
Device Service Limit1	Service interval has exceeded the 'Maint Required Limit' (Device Service Limit 1).	Perform service.
Device Service Limit2	Service interval has exceeded the 'Maint Demanded Limit' (Device Service Limit 2).	Perform service.
Calibration Schedule Limit1	Calibration interval has exceeded the 'Maint Required Limit' (Calibration Schedule Limit 1).	Perform calibration.
Calibration Schedule Limit2	Calibration interval has exceeded the 'Maint Demanded Limit' (Calibration Schedule Limit 2).	Perform calibration.

Unit Repair and Excluded Liability

All changes and repairs must be done by qualified personnel and applicable safety regulations must be followed. Please note the following:

- The user is responsible for all changes and repairs made to the device.
- All new components must be provided by Siemens Milltronics Process Instruments Inc.
- Restrict repair to faulty components only
- Do not re-use faulty components.

Notes:

Antenna Maintenance

Cleaning the Antenna

If the antenna is contaminated, any built-up material can be removed using air or soft brushes. Be careful not to damage the PTFE emitter cone inside the antenna.

An optional purge kit is available from Siemens Milltronics if required. Contact your local Siemens Milltronics representative for more details.

Hazardous Installation

The necessary certificates are enclosed separately. Please refer to the SITRANS LR400 Certificate manual 7ML19985FP82.

Appendix I

Ambient/Operating Temperature Specification

Appendix I

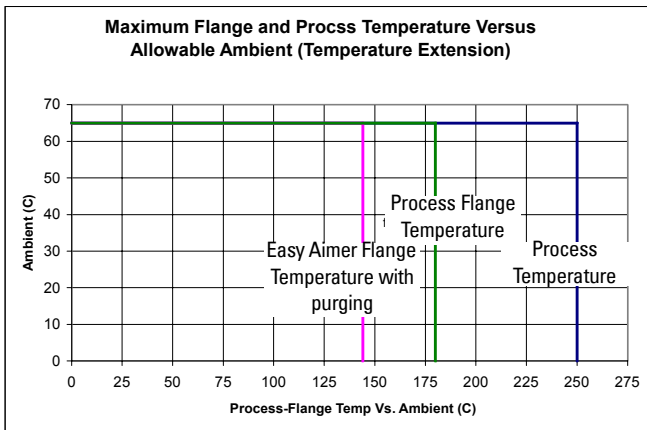
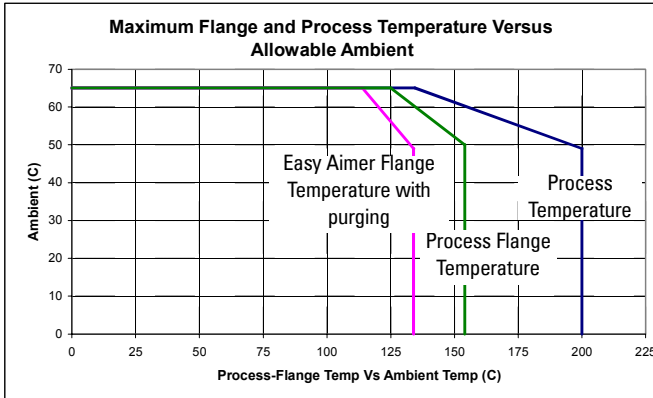

The chart above is provided for guidance only. The chart does not represent every possible process connection arrangement. The chart also does not take into consideration heating from direct sunshine exposure.

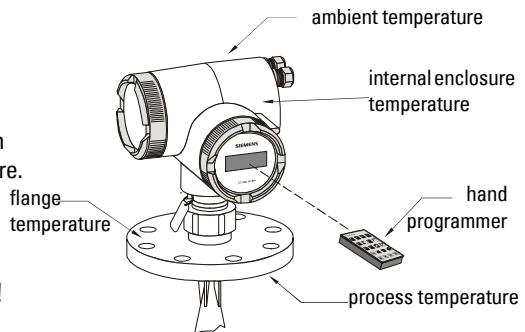

Warning: Internal temperature must not exceed 85 °C (185 °F)! Warranty may be void.

Appendix II

IMPORTANT: The information below is not applicable to the flanges marked with serial numbers from 020102-001 to 020102-128. These flanges are intended for non-pressure applications in North America only.

! **WARNING:** Never attempt to loosen, remove, or disassemble process connection or instrument housing with vessel contents.

Process Pressure/Temperature De-rating

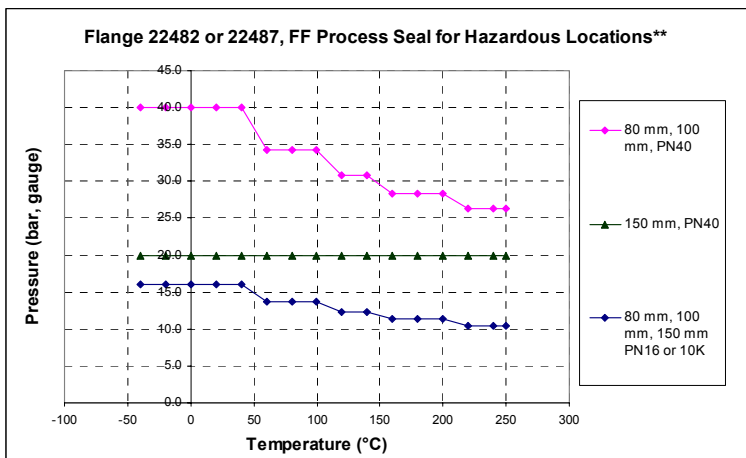
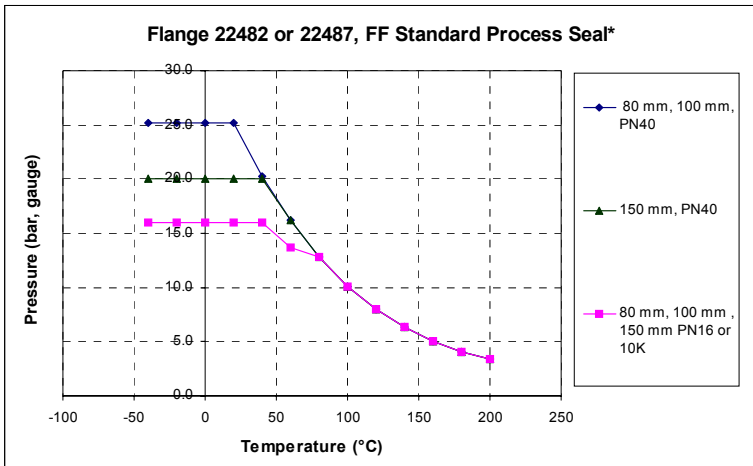

* standard process seal is rated to a max. of 200 °C of continuous duty.

** process seal for hazardous location is rated to a max. of 250 °C of continuous duty.

Appendix II

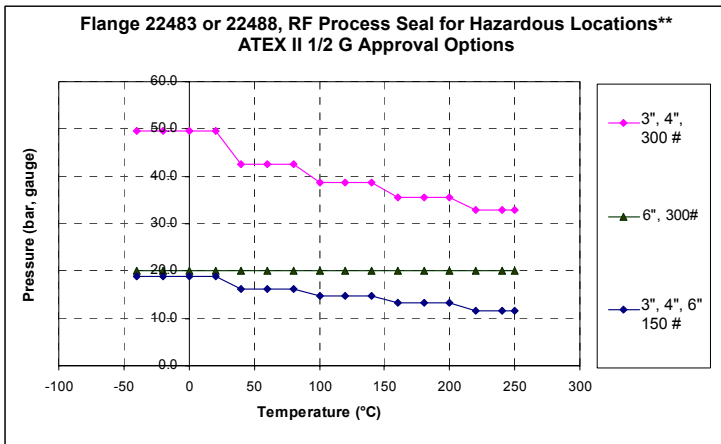
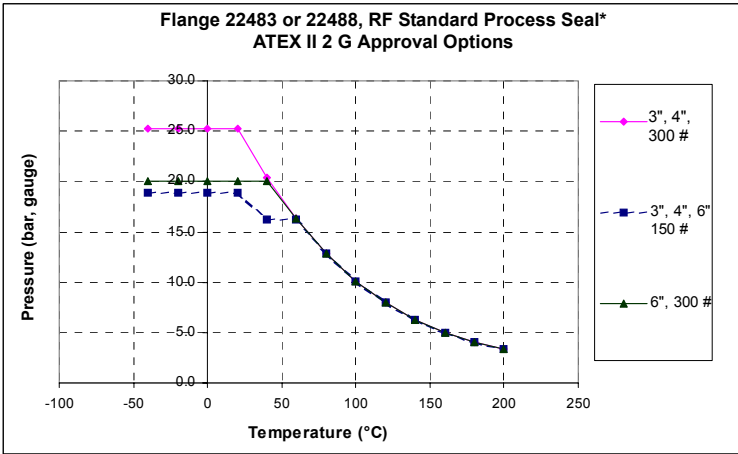

* standard process seal is rated to a max. of 200 °C of continuous duty.

** process seal for hazardous location is rated to a max. of 250 °C of continuous duty.

! WARNINGS:

- Materials of construction are chosen based on their chemical compatibility (or inertness) for general purposes. For exposure to specific environments, check with chemical compatibility charts before installing.
- The user is responsible for the selection of bolting and gasket materials which will fall within the limits of the flange and its intended use and which are suitable for the service conditions.
- Never attempt to loosen, remove, or disassemble process connection or instrument housing with vessel contents.
- Improper installation may result in loss of process pressure.

Appendix III

Measuring Principle

SITRANS LR400 operates according to the FMCW (Frequency Modulated Continuous Wave) method. Its antenna sends microwaves to the surface of the material. The wave frequency is modulated continuously (see Determining the Differential Frequency on 92). A receiver registers the reflection at the surface of the measuring medium and links it with the simultaneously radiated signal.

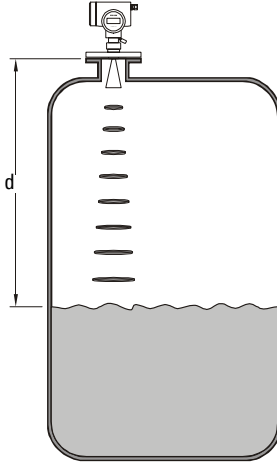

The propagation speed of microwaves in gases corresponds to the speed of light. The distance d is proportional to the propagation time t

$$d = \frac{c \cdot t}{2}$$

d = distance, t = measured time, c = speed of light

As the transmission signal has changed its frequency until the reception signal arrives, the linked signal gives a differential frequency f_d which is proportional to the distance d from the reflecting surface.

The distance d is given by the ratio of the differential frequency f_d to the frequency deviation B and the duration of a frequency modulation phase T :

$$f_d = \frac{2 \cdot B \cdot d}{T \cdot c}, d = \frac{f_d \cdot T \cdot c}{2B}$$

B = bandwidth (frequency deviation), d = distance, T = modulation duration, c = speed of light

Determining the Differential Frequency

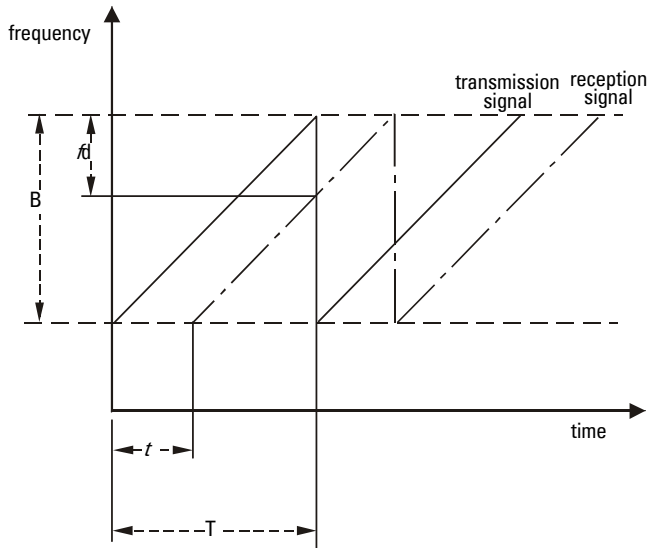

Example

The linear frequency deviation is 200 MHz at a modulation duration of 10 ms. The surface of the measuring medium is 10 m away from the transmitting antenna. The difference signal then has a frequency of:

$$f_d = \frac{2 \cdot 2 \cdot 10^8 \cdot 10}{10^{-3} \cdot 3 \cdot 10^8} = 13,333 \text{ kHz}$$

Every reflection at a surface generates a different frequency. The reception signal therefore consists of a frequency mix from which the disturbance frequencies must be filtered. These can be caused by fixed targets like struts inside the vessel.

Appendix IV

HART Communications for SITRANS LR400

Highway Addressable Remote Transducer, HART, is an industrial protocol that rides on top of a 4-20 mA signal. It is an open standard, and full details about HART can be obtained from the HART Communication Foundation www.hartcomm.org

SITRANS LR400 can be configured over the HART network using either the HART Communicator 275/375 by Fisher-Rosemount, or a software package. The recommended software package is the SIMATIC® Process Device Manager (PDM) by Siemens. SITRANS LR400 should work well with any of the different software packages available.

HART Device Description (DD)

The SITRANS LR400 cannot be set up using a Generic DD. To configure a HART device, the configurator must have the HART Device Description for the SITRANS LR400. All HART DDs are collected by the HART Communication Foundation (HCF) and are placed in the HCF library. Please see the manufacturer of your configurator for an updated HCF library.

HART Version

SITRANS LR400 conforms to HART rev. 5.

Burst Mode

SITRANS LR400 supports burst mode.

SIMATIC Process Device Manager (PDM)

This software package is designed to permit easy configuration, monitoring and troubleshooting of HART and PROFIBUS PA devices. The HART DD for SITRANS LR400 was written with SIMATIC PDM in mind and has been extensively tested with this software. The HART DD for SITRANS LR400 is available on the product page of our website. Go to www.siemens.com/LR400 and click **Downloads**.

HART Communicator 275/375:

Chart 1

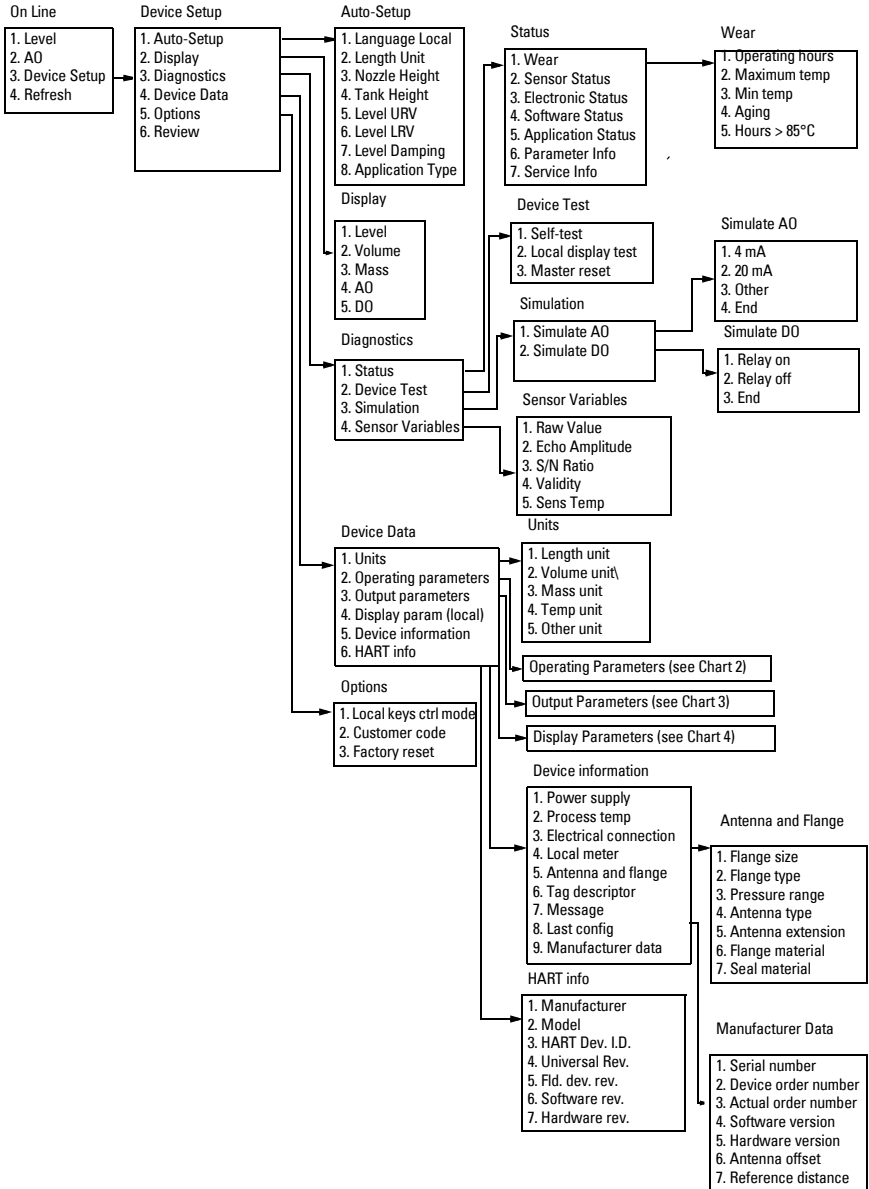

Chart 2

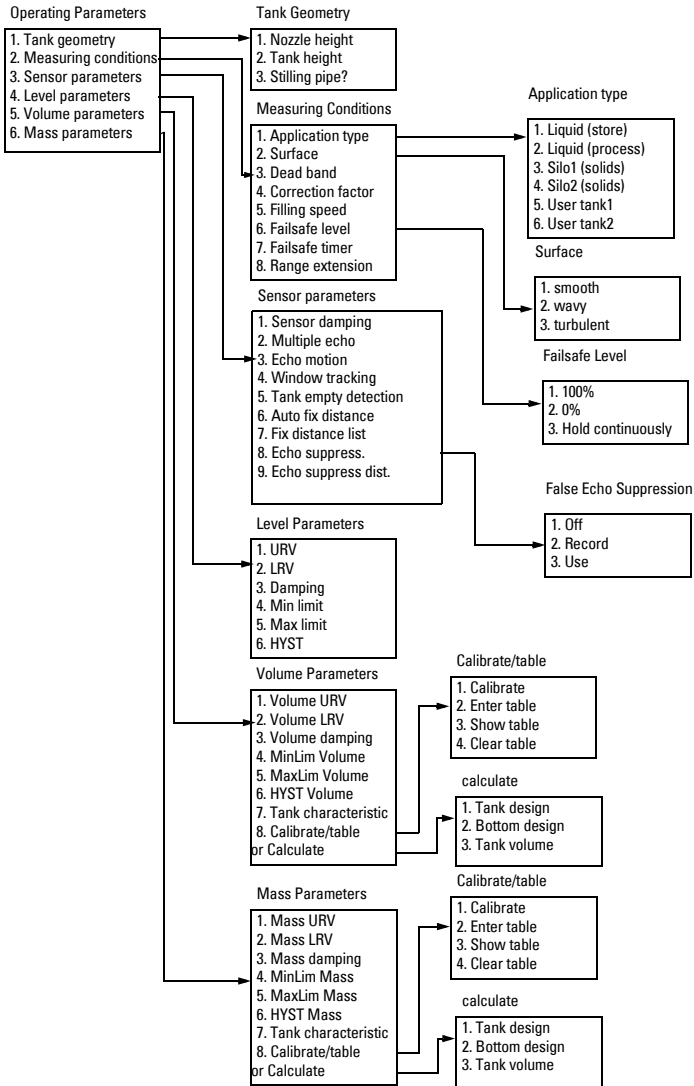

Chart 3

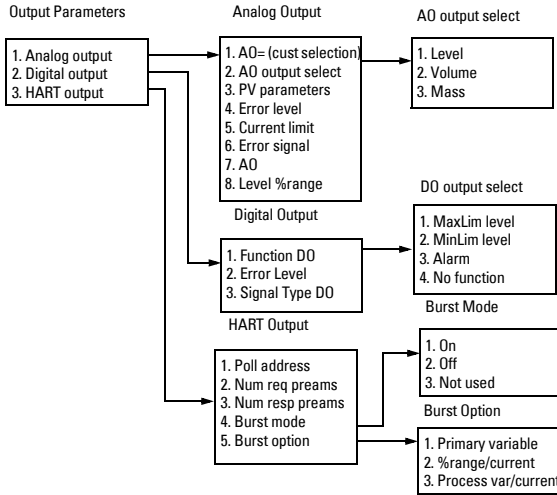
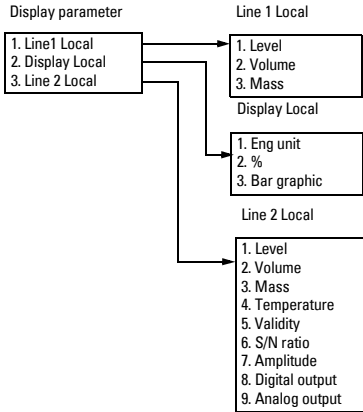

Chart 4



PROFIBUS PA Communications for SITRANS LR400

PROFIBUS PA is an open industrial protocol. Full details about PROFIBUS PA can be obtained from PROFIBUS International at www.profibus.com

SITRANS LR400 is a Profile 3.0, Class A, PA device. It supports Class 1 Master for Cyclic data exchange, and Class 2 for acyclic services: (See below for details).

SITRANS LR400 can be configured using a software package. The recommended software package is the SIMATIC® Process Device Manager (PDM) by Siemens. SITRANS LR400 should work well with any of the different software packages available. Please consult the operating instructions or online help for details on using PDM. For more information, go to www.fielddevices.com: go to Products and Solutions->Products and Systems-> Process Device Manager.

Device Description

In order to use **Process Device Manager (PDM)** with PROFIBUS PA, you will need the Device Description, which will be included with new versions of PDM. Currently you can locate the Device Description in **Device Catalog**, under **Level/Echo/Siemens Milltronics**. If you do not see **SITRANS LR400** under Siemens Milltronics, you can download it from our web site. Go to the SITRANS LR400 product page at: www.siemens.com/LR400 and click **Downloads**.

The GSD file

The GSD file **SM_062A.GSD** is available from our website. You can download it from our web site. Go to the SITRANS LR400 product page at: www.siemens.com/LR400 and click **Downloads**. (There is an example on page 101: *To configure and use PROFIBUS PA with an S7-300 PLC.*)

Bus address (Device Address)

Values	Range: 0 to 126
	Pre-set: 126

- This value can be set via Bus Address in the Auto-setup parameters, or over the network. (After changing the value, turn the unit off and back on again in order for the change to take effect.)

Bus Termination

Note: PROFIBUS PA MUST be terminated at both extreme ends of the cable to work properly. Please refer to the PROFIBUS PA User and Installation Guidelines (order number 2.092), available from www.profibus.com.

Power Demands

To determine how many devices can be connected to a bus line, calculate the combined maximum current consumption of all the connected devices: 10.5 mA for SITRANS LR400. Allow a current reserve for safety

Cyclic versus Acyclic Data

When you request data from a device via PROFIBUS PA, you have two choices. Cyclic data is provided at every bus scan; acyclic data is requested and provided as needed.

Input and output information is always requested at every bus scan and is set up as cyclic data. Configuration information is only needed periodically and is set up as acyclic data.

Cyclic Data

When you configure SITRANS LR400 on the PROFIBUS PA bus, there are two slots available for modules.

Note: Each of the slots has to have a module defined in it.

Slot 0 always transmits **Level** information and slot 1 always **Volume** information. Slot2 is always **Mass** information. If you do not wish to have data transmitted, then you must use a **Free Place** module in that slot.

When you select a module, for the three values, there are two alternatives: a normal version and a short version, for example, **Level (short)** and **Level**. The difference between the two is the way each one identifies the function block used. **Level** uses both the identifier and the extended identifier byte to determine which function block in the unit to use. **Level (short)** uses only the identifier byte. In the current release of PROFIBUS PA there is no functional difference between the short and normal versions. However, the longer identifier is the preferred way to identify the function block.

The 3 function blocks (**Level, Volume, Mass**) return 5 bytes of data each:

	Floating Point				Status
Level	byte 1	byte 2	byte 3	byte 4	byte 5
Volume	byte 6	byte 7	byte 8	byte 9	byte 10
Mass	byte 11	byte 12	byte 13	byte 14	byte 15

The first 4 bytes are the floating point representation (IEEE) of the variable. The variables are the outputs of the function block. The default setting for the variable **level** is meters. The default setting for the variable **volume** is m^3 . The default setting for the variable **mass** is kg. You can change the settings of the variables by changing the settings of the function block. This is typically done using PDM.

The 5th byte is the status word and the list of possible values is given in the chart on page 100.

The 5 bytes must be read consistently, in a contiguous chunk: they cannot be read byte by byte, and cannot suffer an interrupt. If you are using an S7-300/400, you will need to use SFC14 DPRD_DAT: Read Consistent Data of a Standard PD Slave.

If you select a Free Place module to fill one of the slots, this will affect the byte number. Example 1:

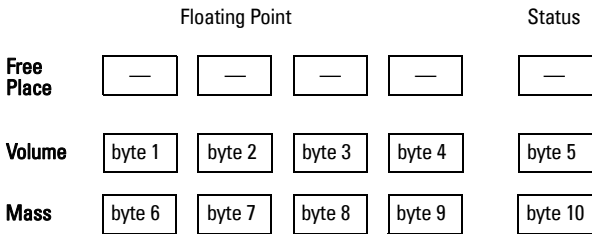

Example 2:

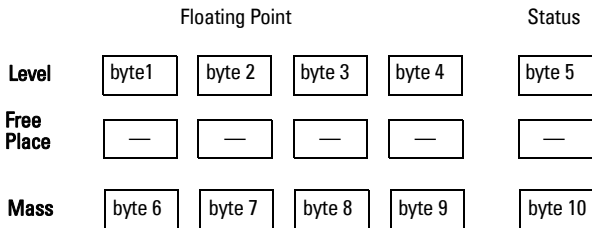

Status Word

Values in hex notation	Description
Status Codes for Good Quality	
0x8E	high limited active critical alarm
0x8D	low limited active critical alarm
0x8A	high limited active advisory alarm
0x89	low limited active advisory alarm
0x84	active update event
0x80	ok (data is good)
0xA4	maintenance required
Status Codes for Uncertain Quality	
0x4F	initial value
0x4C	uncertain: initial value
0x4B	substitute set
0x47	last usable value
0x42	high limited non-specific
0x41	low limited non-specific
0x40	non-specific
0x52	sensor conversion not accurate
Status codes for Bad Quality	
0x1F	out of service
0x0F	constant device failure
0x0C	device failure
0x13	constant sensor failure
0x12	high limited sensor failure
0x11	low limited sensor failure
0x10	sensor failure
0x07	constant configuration error

Extended Diagnostics

The last four bytes of the extended diagnostics message are as follows.

Hex values	Byte	Bit	Description	Indication class ¹
0x01000000	0	0	Electronics failure	R
0x02000000		1	Mechanical failure	R
0x04000000		2	Motor Temperature too high	R
0x08000000		3	Electronics temperature too high	R
0x10000000		4	Memory error	R
0X20000000		5	Measurement failure	R
0X40000000		6	Device not initialized (no calibration)	R
0x80000000		7	Self calibration failed	R
0x00010000	1	0	Zero point error (limit position)	R
0x00020000		1	Power supply failure	R
0x00040000		2	Configuration invalid	R
0x00080000		3	New startup carried out (Warm Start)	A
0x00100000		4	Restart carried out (Cold Start)	A
0X00200000		5	Maintenance required	R
0X00400000	3	6	Characterization invalid	R
0X00000080		7	More diagnosis information is available	

1. **R** indicates the message remains active as long as the reason for the message exists.
A indicates the message will automatically reset after 10 seconds

Values of the DIAGNOSIS bit:

0 = not set

1 = set

Acyclic Data

SITRANS LR400 supports up to three simultaneous connections by a class 2 Master (C2 connection). It does not support Master Class 1 (C1 connection).

Configuration Example:

To configure and use PROFIBUS PA with an S7-300/400 PLC

1. Import the GSD file **SM_062A.GSD**.
2. Add SITRANS LR400 "rack": click and drag SITRANS LR400 folder from the hardware catalog.
3. Fill the rack with desired modules, by dragging and dropping them from the hardware catalog.
4. After configuring PROFIBUS PA in steps 2 and 3, download it to the PLC.
5. Add code to the PLC program to read data consistently using the SFC14.

Appendix VI: Firmware Revision History

Firm-ware Rev.	Date	Changes
2.0	Jan. 1, 2002	<ul style="list-style-type: none">• Original software release
2.1	Feb. 5, 2002	<ul style="list-style-type: none">• Corrected HART board reset.• Updated many menu items.• Improved multiple echo detection when only two echoes occur.• Resolution of TVT increased.• Leading edge detection improved.• TVT is no longer reset on factory reset.
2.2	Aug. 27, 2002	<ul style="list-style-type: none">• Sensitivity of the display-mounted keys increased.• Level damping max value increased.• Silo2 default settings changed.• Corrected S/N value of over 700 being displayed when the auto noise order was set to 0• First Echo algorithm improvement
2.3	Jan. 23, 2003	<ul style="list-style-type: none">• Sensitivity of the display-mounted keys reduced.
2.4	Apr. 23, 2003	<ul style="list-style-type: none">• Alarm mode relays now latches during alarm.
3.0	Apr. 1, 2004	<ul style="list-style-type: none">• Removed support for the front keypad; added support for the hand programmer.• Added dynamic TVT hover level feature.• Added translations to support both English and German.• Moved all the USER1 and USER2 service fields to the standard DD under new folder called "Advanced Echo Processing"• Added support for new parameters (hover level and window trigger)• Changes to the echo profile graph in SIMATIC PDM to correspond to other Siemens Milltronics products.• Cleanup/addition of default values and help messages• Added manual TVT shaper command to SIMATIC PDM.

Firm-ware Rev.	Date	Changes
3.1	Aug. 19, 2004	<ul style="list-style-type: none"> • DDs: Initial quality value for PROFIBUS blocks set to 0x4C "uncertain: initial value" • DDs: Corrected several default values that did not match the device and were different on a master reset • HCF 275 Hand Held DD changes to include the new parameters in release • All parameters available locally at the LR400 device are now documented in the manual.
3.2	Sept. 20, 2004	<ul style="list-style-type: none"> • Extended range calibration limits
3.3	Oct. 28, 2004	<ul style="list-style-type: none"> • Specific dead bands per horn type have been removed. All horn types now have a dead band of 0.35 meters. • Several new values have been added to antenna and flange parameters to support the new antenna and flange options. • Reset failures caused by certain filling speed settings have been corrected.
3.7	Feb. 22, 2006	<ul style="list-style-type: none"> • Fault Simulation Feature added, for service purposes only. • MP&F maintenance support added. New parameters and support added for Device lifetime, Sensor lifetime, maintenance required and calibration required. • Corrected "inconsistent parameter values" warning when tank height causes a maximum volume less than the max. volume parameter. • SILO2 SEARCH_BIG_X_MAX now defaults to OFF (not user-editable). • Limited density value to reasonable value. Large invalid values were causing the LR400 to reset. • Fixed issue regarding Volume/Mass table entry deletion • Fixed issue using g/cm³ density units
3.14	May 17, 2008	<ul style="list-style-type: none"> • PROFIBUS PA, quality 0x40 and diagnosis octet 1, bit 5 set only after LOE expired

Glossary

accuracy: degree of conformity of a measure to a standard or a true value.

ADC: analog to digital converter

ambient temperature: the temperature of the surrounding air that comes in contact with the enclosure of the device.

antenna offset: propagation time of the signal in the sensor, expressed as a distance.

Auto False-Echo Suppression: a technique used to adjust the level of a TVT curve to avoid the reading of false echoes. (See TVT.)

Auto False-Echo Suppression Distance: defines the endpoint of the TVT distance. (See TVT.) This is used in conjunction with auto false echo suppression.

beam angle: the angle diametrically subtended by the one-half power limits (-3 dB) of the sound beam.

beam spreading: the divergence of a beam as it travels through a medium.

blanking: a blind zone extending away from the reference point plus any additional shield length. The instrument is programmed to ignore this zone.

confidence: describes the quality of an echo. Higher values represent higher quality. Confidence threshold defines the minimum value.

current limit: The maximum possible value of the output signal in fault-free operation in mA. The value of the fail signal may be above the current limit with 24 mA.

damping: term applied to the performance of an instrument to denote the manner in which the measurement settles to its steady indication after a change in the value of the level.

dB (decibel): a unit used to measure the amplitude of signals.

dead band (blanking): a blind zone extending away from the reference point plus any additional shield length. The instrument is programmed to ignore this zone.

derating: to decrease a rating suitable for normal conditions according to guidelines specified for different conditions.

dielectric: a nonconductor of direct electric current.¹

dielectric constant (DK): the ability of a dielectric to store electrical potential energy under the influence of an electric field. Also known as Relative Permittivity. An increase in the

¹ Many conductive liquids/electrolytes exhibit dielectric properties; the relative dielectric constant of water is 80.

dielectric constant is directly proportional to an increase in signal amplitude. The value is usually given relative to a vacuum /dry air: the dielectric constant of air is 11.

DSP: Digital signal processor

echo: a signal that has been reflected with sufficient magnitude and delay to be perceived in some manner as a signal distinct from that directly transmitted. Echoes are frequently measured in decibels relative to the directly transmitted signal.

echo confidence: the recognition of the validity of the echo. A measure of echo reliability.

Echo Lock Window: a window centered on an echo in order to locate and display the echo's position and true reading. Echoes outside the window are not immediately processed.

Echo Processing: the process by which the radar unit determines echoes.

Echo Strength: describes the strength of the selected echo in dB above 1 μ V rms.

Echo Profile: a graphical display of a processed echo.

false echo: any echo which is not the echo from the desired target. Generally, false echoes are created by vessel obstructions.

fixed target: permanently installed objects inside the vessel which may cause reflective interference, e.g. struts, agitators, feed pipes, etc.

FMCW: Frequency Modulated Continuous Wave method

frequency: the number of periods occurring per unit time. Frequency may be stated in cycles per second.

frequency deviation: changing the transmission frequency in the FMCW method

hertz (Hz): unit of frequency, one cycle per second. 1 Gigahertz (GHz) is equal to 10^9 Hz.

horn antenna: a conical, horn-shaped antenna which focuses microwave signals. The larger the horn diameter, the more focused the radar beam.

LRV: Lower limit of the valid measuring range as a distance from the bottom inside of the vessel.

material or measuring medium: the contents of the vessel

microwaves: the term for the electromagnetic frequencies occupying the portion of the radio frequency spectrum from 1 GHz to 300 GHz.

multiple echoes: secondary echoes that appear as double, triple, or quadruple echoes in the distance from the target echo.

nozzle: a length of pipe mounted onto a vessel that supports the flange.

nozzle height: distance from the top of the inside of the vessel to the bottom of the device flange.

parameters: in programming, variables that are given constant values for specific purposes or processes.

PELV: Protected Extra Low Voltage

PROFIBUS PA: one of the PROFIBUS family of protocols, specifically tailored for the needs of process industries (PA = Process Automation).

propagation factor (pf): where the maximum velocity is 1.0, pf is a value that represents a reduction in propagation velocity as a result of the wave travelling through a pipe or medium.

PTFE: Polytetrafluorethylene

radar: radar is an acronym for **RA**dio **D**etection **A**nd **R**anging. A device that radiates electromagnetic waves and utilizes the reflection of such waves from distant objects to determine their existence or position.

range: distance between a transmitter and a target.

range extension: the distance below the zero percent or empty point in a vessel.

repeatability: the closeness of agreement among repeated measurements of the same variable under the same conditions.

SELV: Safety Extra Low Voltage

shot: one transmit pulse or measurement.

Signal-to-noise ratio: measure of the strength of reflection of the measuring medium in the current measuring situation in dB.

speed of light: the speed of electromagnetic waves (including microwave and light in free space. Light speed is a constant 299,792,458 meters per second.

SSC/ASC: synchronous serial communications/asynchronous serial communications

stillpipe: a pipe that is mounted inside a vessel perpendicular to the vessel wall, and is open to the vessel at the bottom.

stilling-well: see **stillpipe**.

TVT (time varying threshold): a time-varying curve that determines the threshold level above which echoes are determined to be valid.

URV: Upper limit of the valid measuring range as a distance from the bottom inside of the vessel

validity: measure of the certainty of the current measured value in %.

waveguide antenna: a hollow, metallic tube that transmits a microwave signal to the product target.

Index

A

analog output	48
antenna	
cleaning	86
approvals	8
auto-setup	19

B

beam spreading	16
bus address (device address)	97

C

certificates	87
communication	8
connection	17
PROFIBUS	4
cyclic data	98

D

de-rating curves	89, 91
device descriptor	97
digital output	50
dimensions	9
functional	27
display parameters	51

E

extended diagnostics	101
----------------------------	-----

F

Factory Reset	56
fault messages	82
flanges	11
FMCW	91

G

glossary	104
GSD file	97

H

hand programmer	19, 20
HART Communications	
detailed information	93
hysteresis	43

M

maintenance	86
mounting	
location	15

O

operation	20
-----------------	----

output

analog	48
digital	50

P

parameters

analog output	48
auto-setup	27
digital output	50
display	51
HART	26
hysteresis	43
measuring conditions	36
PROFIBUS	68
troubleshooting	31

PDM	93
-----------	----

PROFIBUS	68
----------------	----

programming

disabling	23
enabling	23

purging system	9
----------------------	---

R

Reset

Factory	56
---------------	----

S

self-test	81
-----------------	----

SIMATIC Process Device Manager	93
--------------------------------------	----

specifications	5
----------------------	---

approvals	8
communication	8
de-rating curves	89, 91
performance	5
power	5
temperature charts	88

status word	100
-------------------	-----

structure	3
-----------------	---

T

troubleshooting	81
-----------------------	----



www.siemens.com/processautomation

Siemens Milltronics Process Instruments Inc.
1954 Technology Drive, P.O. Box 4225
Peterborough, ON, Canada K9J 7B1
Tel: (705) 745-2431 Fax: (705) 741-0466
Email: techpubs.smpi@siemens.com

© Siemens Milltronics Process Instruments Inc. 2008
Subject to change without prior notice



Printed in Canada

7ML5421
Rev. 6.4